



SUNDANCE
PRINT • DESIGN • MAIL • LARGE FORMAT • PACKAGING • LABELS

W D D H A N D B O O K



PPE PRODUCTS



02 | SANITIZING STATIONS & STANDS



10 | SNEEZE GUARDS, PROTECTION WALLS & BARRIERS



24 | FACE MASKS STOCK PATTERNS & CUSTOM PRINTED



28 | SOCIAL DISTANCING CHAIR COVERS, PEEL & STICK WALL SIGNS, FLOOR DECALS

SYMBOL & WARRANTY KEY



lifetime limited warranty (hardware)



5 year limited warranty (hardware)



1 year limited warranty (hardware)



90 day limited warranty (hardware)

PPE PRODUCTS

OUTDOOR CURBSIDE SIGNS,
FLAGS & BANNERS | 34



OUTDOOR HANGING BANNERS | 42



OUTDOOR TENTS | 44



INTERIOR SIGNS, BANNERS,
SIGN STANDS | 48



SYMBOL & WARRANTY KEY



graphics limited
1 year warranty
(indoor products)



graphics limited
6 month warranty
(outdoor & table
throw products)



graphics limited
90 day warranty
(plex products)



product made in
North America

SANITIZING STATIONS & STANDS





SANITIZING STATIONS & STANDS

BANNITIZER™ SANITIZING STATION

- variable graphic height = 60"-83"
- 1000ml battery operated **hands-free** sanitizer dispenser with lock included
- requires four C batteries
- takes sanitizing liquid or gel
- accessory channel holds upright and sanitizer dispenser
- hybrid bungee/telescoping pole with toolless quick rail
- adjustable feet on base
- anodized silver base only
- quick slide graphic to leader attachment
- graphic tensioner
- includes carry bag with strap

	ITEM #	DESCRIPTION
31.5" WIDE	HS1-BCD-800-KIT	Bannitizer Sanitizing Station, Single-Sided Graphic Kit
	HS1-BCD-800	Hardware only

*kits include hardware, graphic & carry bag

hands-free sanitizing station!
PERFECT FOR ENTRYWAYS



side view



1000ml capacity



visual window



dispenser with lock

STOCK ARTWORK OPTIONS





TRAPPA™ TUBE SANITIZER STAND

- 1000ml battery operated, **hands-free** sanitizer dispenser with lock included
- requires four C batteries
- takes sanitizing liquid or gel
- 11"x17" silver Trappa poster frame with clear, protective lens
- front loading graphic mechanism makes graphic changes easy
- capability to display in portrait or landscape configuration
- aluminum snap-button tube and plastic base
- assembled dimensions = 12"w x 64.75"h x 12"d
- sanitizer solution sold separately

ITEM #	DESCRIPTION
TRAPPA-TUBE-SANI-TRP2-11-S	Trappa Tube Sanitizer Stand Hardware
TRP2-11-G	Trappa Tube Sanitizer Stand Graphic

hands-free sanitizing dispenser included!



TRAPPA STEEL SANITIZER STAND

- 1000ml battery operated, **hands-free** sanitizer dispenser with lock, uses gel or liquid
- requires four C batteries
- 11"w x 8.5"h black Trappa poster frame can be positioned portrait or landscape
- Trappa frame comes with clear, protective lens
- front loading graphic mechanism makes graphic changes easy
- sturdy steel post and steel base
- assembled dimensions = 12"w x 64"h x 12"d
- sanitizer solution sold separately

ITEM #	DESCRIPTION
TRAPPA-STEEL-SANI-STAND	Trappa Steel Sanitizer Stand Hardware



TRAPPA POST SANITIZER STAND

- 1000ml battery operated, **hands-free** sanitizer dispenser with lock included
- requires four C batteries
- takes sanitizing liquid or gel
- 16"x20" silver Trappa poster frame with clear, protective lens
- front loading graphic mechanism makes graphic changes easy
- sturdy aluminum post and heavy domed steel base
- assembled dimensions = 20"w x 74"h x 18"d
- sanitizer solution sold separately

ITEM #	DESCRIPTION
TRAPPA-POST-SANI-TRP2-4-S	Trappa Post Sanitizer Stand Hardware
TRP2-4-G	Trappa Post Sanitizer Stand Graphic



SANITIZING STATIONS & STANDS



CIRCLE TRAPPA™ POST SANITIZER STAND

- 1000ml battery operated, **hands-free** sanitizer dispenser with lock included
- requires four C batteries
- takes sanitizing liquid or gel
- sturdy 1200mm/4ft tall aluminum post and heavy domed steel base plate ensure stability
- assembled dimensions = 20" w x 60" h x 18" d
- sanitizer solution sold separately

ITEM #	DESCRIPTION
TRAPPA-POST-SANI-1200-K-C	Circle Trappa Post Sanitizer Stand Kit
TRAPPA-POST-SANI-1200	Hardware only

perfect way to welcome patrons!

DAYCARE FACILITIES, PLACES OF WORSHIP, SCHOOLS, RETAIL STORES & MORE



OVAL TRAPPA™ POST SANITIZER STAND

- 1000ml battery operated, **hands-free** sanitizer dispenser with lock included
- requires four C batteries
- takes sanitizing liquid or gel
- sturdy 1200mm/4ft tall aluminum post and heavy domed steel base plate ensure stability
- assembled dimensions = 18" w x 60" h x 18" d
- sanitizer solution sold separately

ITEM #	DESCRIPTION
TRAPPA-POST-SANI-1200-K-O	Oval Trappa Post Sanitizer Stand Kit
TRAPPA-POST-SANI-1200	Hardware only



RECTANGLE TRAPPA™ POST SANITIZER STAND

- 1000ml battery operated, **hands-free** sanitizer dispenser with lock included
- requires four C batteries
- takes sanitizing liquid or gel
- sturdy 1200mm/4ft tall aluminum post and heavy domed steel base plate ensure stability
- assembled dimensions = 18" w x 60" h x 18" d
- sanitizer solution sold separately

ITEM #	DESCRIPTION
TRAPPA-POST-SANI-1200-K-R	Rectangle Trappa Post Sanitizer Stand Kit
TRAPPA-POST-SANI-1200	Hardware only

heavy-domed steel base ensures stability





TEMP-SANI STAND

- **hands-free**, battery operated temperature gauge, requires three AA batteries
- **hands-free** 1000ml battery operated, sanitizer dispenser with drip tray, requires four C batteries
- silver, aluminum snapping poster frame, holds A4 size paper - 11.75"w x 8.25"h
- telescoping pole, min. height: 56", max height: 71"
- while at min. height, center of temperature screening unit is 44"h
- while at max. height, center of temperature screening unit is 59.25"h
- sturdy, rectangular weighted base ensures stability
- sanitizer solution sold separately

ITEM #	DESCRIPTION
HS-TEMP-STAND	Hands-free Temperature Sanitizing Station
HS-TEMP-STAND-G	A4 Size Insert for Temp-Sani Stand, 22mil Opaque PVC

heavy-domed steel base ensures stability



DESKTOP SANITIZING DISPENSER

- stand-alone **hands-free**, refillable desktop sanitizer dispenser
- features a white, sturdy, steel base that the dispenser attaches to at the back
- requires four C batteries
- takes sanitizing liquid or gel
- assembled unit dimensions = 8"w x 20"h x 8"d

ITEM #	DESCRIPTION
HSI-DESKTOP-STAND-WHITE-KIT	Desktop Sanitizing Station

perfect for reception desks & counters





SANITIZING STATIONS & STANDS



canvas with zip closure

back view

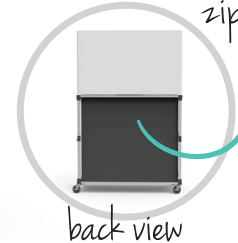

canvas with zip closure

back view

POPUP SANI-CART MINI

- 23.94" w x 60" h x 20" d
- small, portable sanitizing station, perfect for use in any environment
- pre-assembled aluminum frame, pops up to assemble
- zipper-enclosed storage space holds garbage can and supplied needed*
- pullover fabric graphic identifies the station
- locking wheel casters
- can be used as a pull cart
- kit includes cart, graphic, one shelf and carry bag

ITEM #	DESCRIPTION
POPUP-SANI-CART-MINI	Small Popup Sanitizing Cart
PBFM902-B-G	Cart Graphics
PBFM-R-H-SANI-G	Header Graphic

POPUP SANI-CART LARGE

- 40.13" w x 60" h x 20.06" d
- large portable sanitizing station, perfect for use in any environment
- pre-assembled aluminum frame, pops up to assemble
- zipper-enclosed storage space holds garbage can and supplied needed*
- pullover fabric graphic identifies the station
- locking wheel casters
- can be used as a pull cart
- kit includes cart, graphic, one shelf and carry bag

ITEM #	DESCRIPTION
POPUP-SANI-CART-LARGE	Large Popup Sanitizing Cart
PBFL301-B-G	Cart Graphics
PBFL-R-H-SANI-G	Header Graphic

plenty of storage space for supplies!



back view

canvas with zip closure



simple assembly!

*supplies and accessories not included.

SANITIZING STATIONS & STANDS



1000ml hands-free sanitizing dispenser & drip tray



temperature gauge sounds alarm if temp exceeds 98.6°F

DefenderStretch antimicrobial fabric graphic

WELLNESS STATION

- hands-free temperature gauge
- battery operated, takes three AA batteries
- alarm sounds if temperature exceeds 98.6°F
- hands-free 1000ml sanitizer dispenser w/ drip tray
- battery operated, takes four C batteries
- DefenderStretch antimicrobial fabric graphic
- protective coating inhibits the growth of microorganisms, fungus and bacteria
- offered with or without endcaps
- attaches with hook & loop
- 8ft wide (3 x 3 quad) straight collapsible frame
- assembled unit dimensions: 89" w x 89" h x 12" d
- internal mounts (2) hold temperature gauge and sanitizer dispenser
- adjustable stabilizing feet
- optional wheeled hard case

ITEM #	DESCRIPTION
WELLNESS-CHECK-3X3-FG-KIT	Wellness Station: Graphic no end caps, no case
WELLNESS-CHECK-3X3-OCX-FG-KIT	Wellness Station: Graphic no end caps, with case
WELLNESS-CHECK-3X3-FGE-KIT	Wellness Station: Graphic with end caps, no case
WELLNESS-CHECK-3X3-OCX-FGE-KIT	Wellness Station: Graphic with end caps, with case

perfect for entryways!

HANDS-FREE TEMPERATURE CHECK & SANITIZING STATION



SANITIZING STATIONS & STANDS

a fast, economy wellness display



hands-free temp gauge

4 attach the gauge & dispenser



hands-free sanitizing dispenser



3 lock the arms & attach the graphic



2 expand frame & add internal mounts

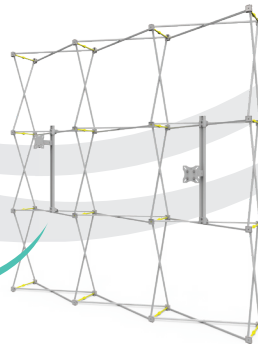

1 take frame out of the carry bag



SNEEZE GUARDS, PROTECTION WALLS & BARRIERS





ACRYLIC SNEEZE GUARDS

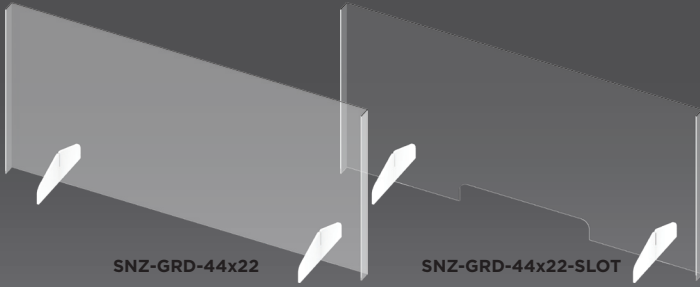

SNZ-GRD-44x22

SNZ-GRD-44x22-SLOT

44" w x 22" h

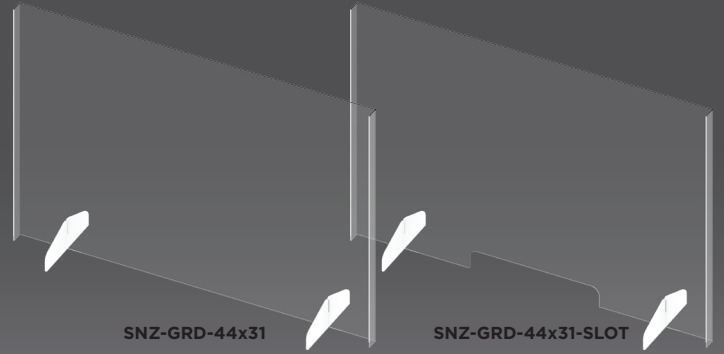

SNZ-GRD-44x31

SNZ-GRD-44x31-SLOT

44" w x 31" h

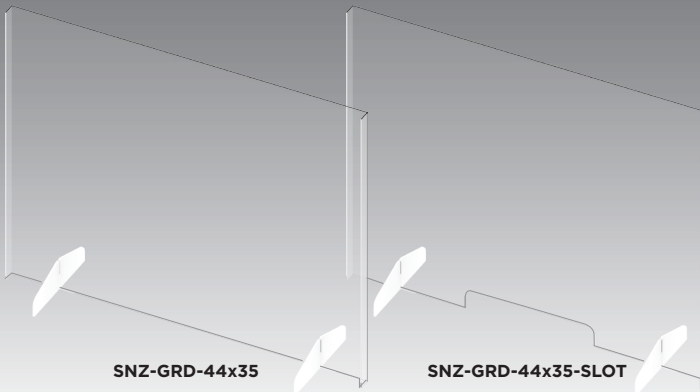

SNZ-GRD-44x35

SNZ-GRD-44x35-SLOT

44" w x 35" h

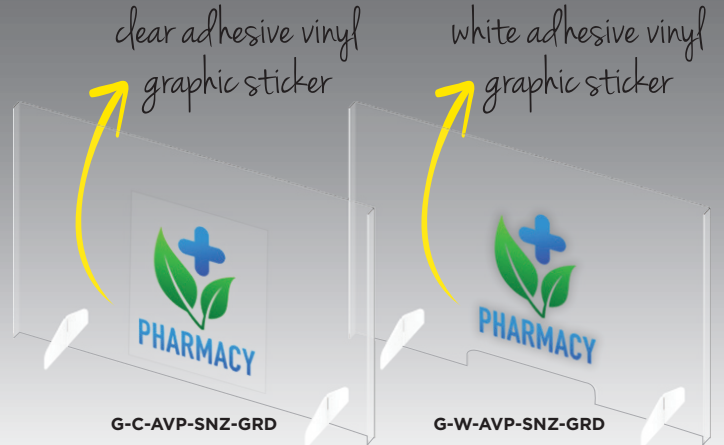

clear adhesive vinyl graphic sticker

white adhesive vinyl graphic sticker

G-C-AVP-SNZ-GRD

G-W-AVP-SNZ-GRD

CLEAR ACRYLIC SNEEZE GUARDS FOR TABLETOPS

- 1/8" thick
- 44" wide
- choice of 22", 31" or 35" heights
- bank slots offered for all sizes
- white sintra feet
- made in North America
- custom shapes also available within 44" w x 35" h size

ITEM #	DESCRIPTION
SNZ-GRD-44x22	Sneeze Guard 44" w x 22" h
SNZ-GRD-44x22-SLOT	Sneeze Guard 44" w x 22" h, with Slot
SNZ-GRD-44x31	Sneeze Guard 44" w x 31" h
SNZ-GRD-44x31-SLOT	Sneeze Guard 44" w x 31" h, with Slot
SNZ-GRD-44x35	Sneeze Guard 44" w x 35" h
SNZ-GRD-44x35-SLOT	Sneeze Guard 44" w x 35" h, with Slot
G-C-AVP-SNZ-GRD	Applied 1st Surface Graphics
G-W-AVP-SNZ-GRD	Cut & Weeded Applied 1st Surface Graphics

vinyl graphics available!

CUSTOMER TO SPECIFY SIZE & PLACEMENT



WARNING: Cancer
www.P65Warnings.ca.gov

PHOENIX MINI BANNER SHIELDS



PHOENIX MINI TABLETOP
17" w



PHOENIX MINI FULL HEIGHT
17" w



retractable protective screens!

PORTABLE & EASY TO MOVE

PHOENIX MINI BANNER SHIELDS

- 7mm thick, clear, rollable polyester
- offered blank or printed single-sided
- easy to wipe clean and disinfect
- 400mm wide
- Phoenix Mini Tabletop Banner comes with two height options: 15.75" (1 pole) or 31.5" h (2 pole)
- Phoenix Mini Full Height version comes with two height options: 47.25" h (3 pole) or 63" h (4 pole)
- snap top graphic rail
- silver base with black endcaps
- includes carry bag
- quick and easy to assemble

	ITEM #	DESCRIPTION
17" WIDE	BS-PHX-400-1P-KIT	Phoenix Mini Tabletop, Blank Shield Kit
	BS-PHX-400-G-1P-KIT	Phoenix Mini Tabletop, Printed Shield Kit
17" WIDE	BS-PHX-400-4P-KIT	Phoenix Mini Full Height, Blank Shield Kit
	BS-PHX-400-G-4P-KIT	Phoenix Mini Full Height, Printed Shield Kit

*kits include hardware, graphic & carry bag

ideal for reception desks, classrooms, teacher's desks & more



MOSQUITO BANNER SHIELDS

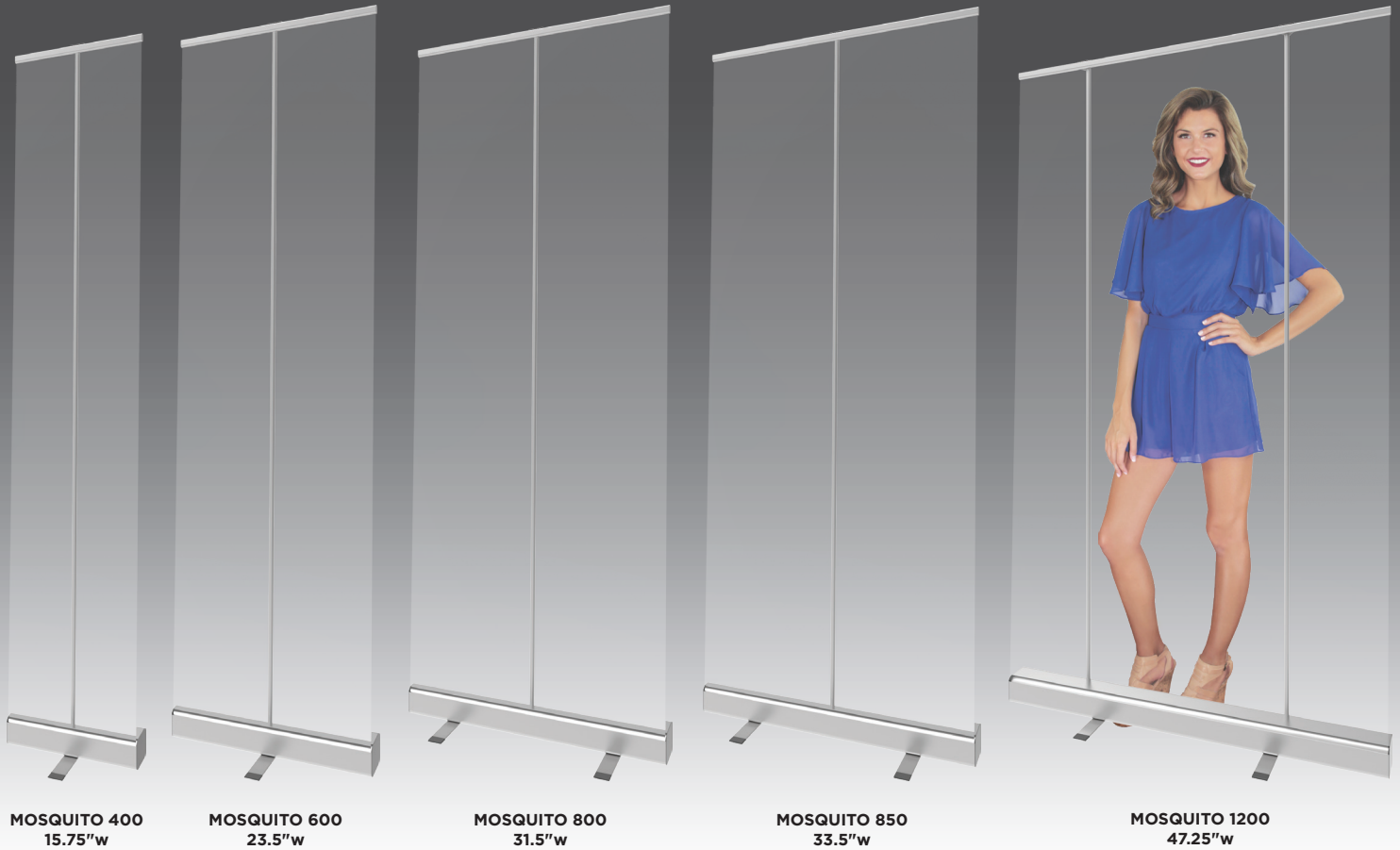

MOSQUITO 400
15.75" w

MOSQUITO 600
23.5" w

MOSQUITO 800
31.5" w

MOSQUITO 850
33.5" w

MOSQUITO 1200
47.25" w

MOSQUITO BANNER SHIELDS

- 7mm thick, clear, rollable polyester
- offered blank or printed single-sided
- easy to wipe clean and disinfect
- 3-piece bungee pole(s)
- snap top graphic rail
- silver base with black end caps & swivel feet
- includes carry bag
- 600mm, 800mm, 850mm, 1200mm have standard height of 78.5"
- 400mm has standard height of 62.5"
- quick and easy to assemble

	ITEM #	DESCRIPTION
15.75" WIDE	BS-MSQT-400-KIT	Mosquito 400, Blank Shield Kit
	BS-MSQT-400-G-KIT	Mosquito 400, Printed Shield
23.5" WIDE	BS-MSQT-600-KIT	Mosquito 600, Blank Shield Kit
	BS-MSQT-600-G-KIT	Mosquito 600, Printed Shield Kit
31.5" WIDE	BS-MSQT-800-KIT	Mosquito 800, Blank Shield Kit
	BS-MSQT-800-G-KIT	Mosquito 800, Printed Shield Kit
33.5" WIDE	BS-MSQT-850-KIT	Mosquito 850, Blank Shield Kit
	BS-MSQT-850-G-KIT	Mosquito 850, Printed Shield Kit
47.25" WIDE	BS-MSQT-1200-KIT	Mosquito 1200, Blank Shield Kit
	BS-MSQT-1200-G-KIT	Mosquito 1200, Printed Shield Kit

*kits include hardware, graphic & carry bag

PEGASUS BANNER SHIELDS



perfect for gyms, beauty & barber shops!



PEGASUS BANNER SHIELDS

- sizes offered:
 - 4'w x 6'h, 5'w x 6'h, 6'w x 6'h
 - 4'w x 8'h, 5'w x 8'h, 6'w x 8'h
- kit includes: 2 feet, 4 telescopic poles for uprights & verticals that connect with push buttons, 4 pole connectors, graphic with clear & scrim vinyl and a carry bag
- choice of silver or black frame
- simply extend telescopic poles to width and height based on graphic selection
- shield includes both a scrim vinyl portion for optimal visibility
 - the scrim vinyl portion is offered printed or unprinted; unprinted is white in color
 - the clear banner material can be cleaned with a soft cloth, mild soap and water

PICK YOUR DESIRED FRAME & SHIELD

ITEM #	DESCRIPTION
Frame, Hardware Only	
PGSUS2-S	Pegasus Standard Frame, Silver
PGSUS2-B	Pegasus Standard Frame, Black
Banner Shield, Unprinted Scrim	
BS-PGSUS2-48X72-BLANK-G	4'w x 6'h Unprinted Scrim
BS-PGSUS2-60X72-BLANK-G	5'w x 6'h Unprinted Scrim
BS-PGSUS2-72X72-BLANK-G	6'w x 6'h Unprinted Scrim
BS-PGSUS2-48X96-BLANK-G	4'w x 8'h Unprinted Scrim
BS-PGSUS2-60X96-BLANK-G	5'w x 8'h Unprinted Scrim
BS-PGSUS2-72X96-BLANK-G	6'w x 8'h Unprinted Scrim
Banner Shield, Printed Scrim	
BS-PGSUS2-48X72-G	4'w x 6'h Printed Scrim
BS-PGSUS2-60X72-G	5'w x 6'h Printed Scrim
BS-PGSUS2-72X72-G	6'w x 6'h Printed Scrim
BS-PGSUS2-48X96-G	4'w x 8'h Printed Scrim
BS-PGSUS2-60X96-G	5'w x 8'h Printed Scrim
BS-PGSUS2-72X96-G	6'w x 8'h Printed Scrim



WARNING: Cancer
www.P65Warnings.ca.gov



PEGASUS BANNER SHIELDS

SIZE OPTIONS



4'w x 6'h



4'w x 8'h



5'w x 6'h



5'w x 8'h



6'w x 6'h



6'w x 8'h

*ideal for classrooms, offices, salons, gyms,
manufacturing operations & more*



WARNING: Cancer
www.P65Warnings.ca.gov

HANGING SNEEZE GUARDS



24"w x 24"h



24"w x 30"h



24"w x 36"h



24"w x 48"h



30"w x 24"h



30"w x 30"h



30"w x 36"h



30"w x 48"h

POSTER SNAPPER HANGING SNEEZE GUARDS

- 16 sizes available off-the-shelf
- aluminum snap frame offered in 4 widths & heights: 24", 30", 36" and 48"
- custom kits with lengths up to 60 inches are available
- durable, lightweight clear polyester is 7mil thick
- offered blank and printed
- snap rail for quick graphic change and easy setup
- easy to wipe clean & disinfect
- hang with s-hook or nylon line (not included)
- assembled in USA



s-hook for easy suspension!

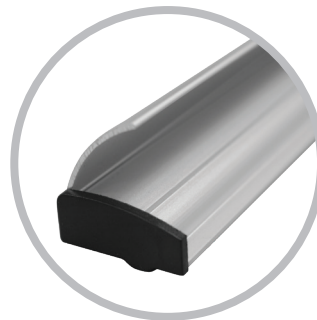

quick graphic change with snap rail edges

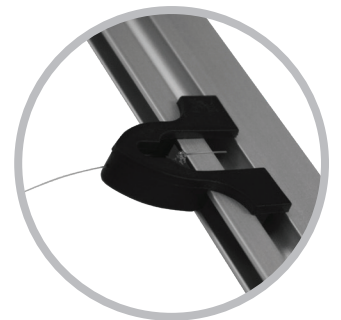

adjustable snap clips



HANGING SNEEZE GUARDS

custom sizes available!

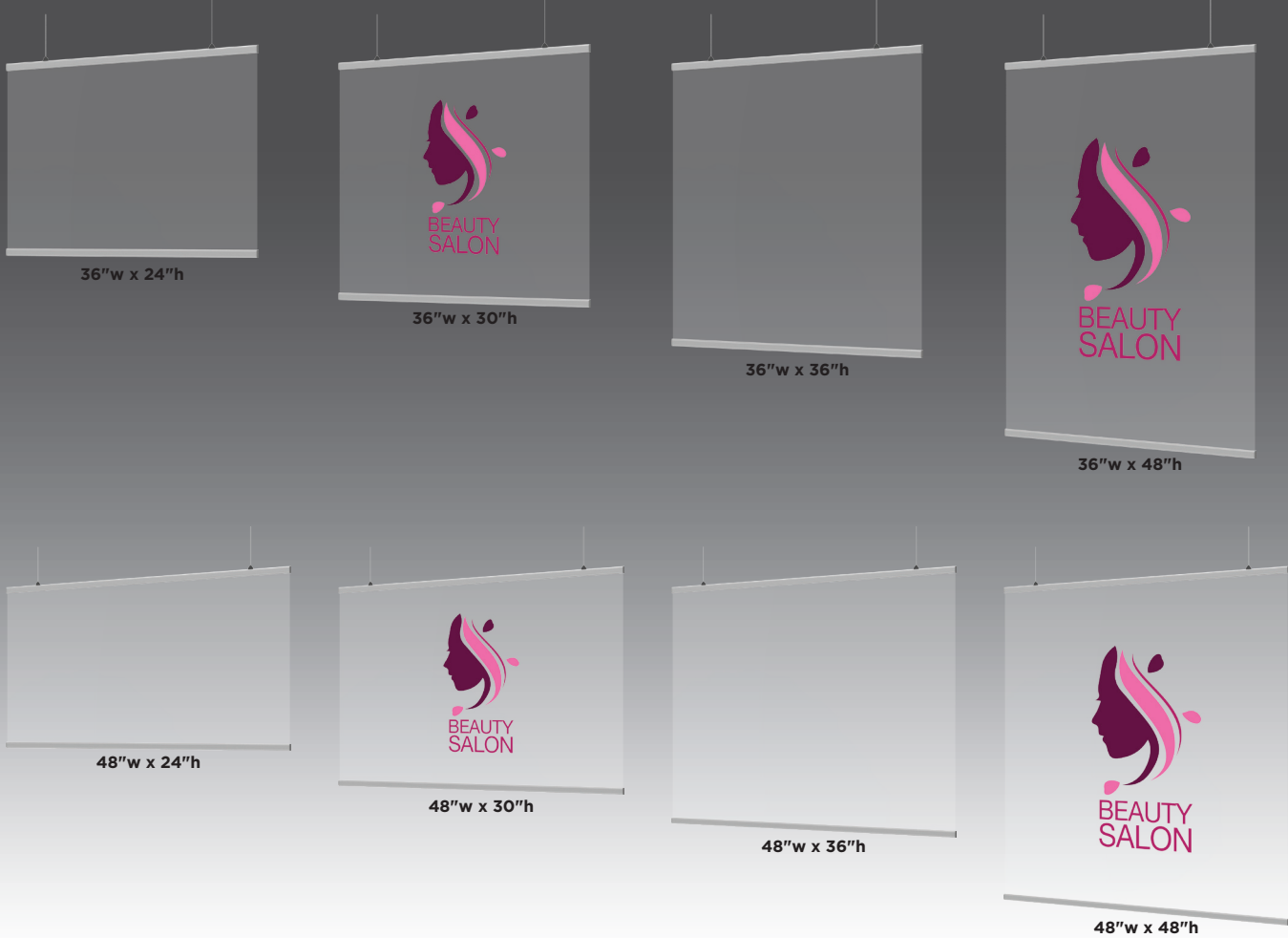

	ITEM #	DESCRIPTION
24" W 24" H	SNZ-POSNP-24-24-CP-KIT	Poster Snapper Kit, Unprinted/Clear
	SNZ-POSNP-24-24-G-KIT	Poster Snapper Kit, Printed
24" W 30" H	SNZ-POSNP-24-30-CP-KIT	Poster Snapper Kit, Unprinted/Clear
	SNZ-POSNP-24-30-G-KIT	Poster Snapper Kit, Printed
24" W 36" H	SNZ-POSNP-24-36-CP-KIT	Poster Snapper Kit, Unprinted/Clear
	SNZ-POSNP-24-36-G-KIT	Poster Snapper Kit, Printed
24" W 48" H	SNZ-POSNP-24-48-CP-KIT	Poster Snapper Kit, Unprinted/Clear
	SNZ-POSNP-24-48-G-KIT	Poster Snapper Kit, Printed
30" W 24" H	SNZ-POSNP-30-24-CP-KIT	Poster Snapper Kit, Unprinted/Clear
	SNZ-POSNP-30-24-G-KIT	Poster Snapper Kit, Printed
30" W 30" H	SNZ-POSNP-30-30-CP-KIT	Poster Snapper Kit, Unprinted/Clear
	SNZ-POSNP-30-30-G-KIT	Poster Snapper Kit, Printed
30" W 36" H	SNZ-POSNP-30-36-CP-KIT	Poster Snapper Kit, Unprinted/Clear
	SNZ-POSNP-30-36-G-KIT	Poster Snapper Kit, Printed
30" W 48" H	SNZ-POSNP-30-48-CP-KIT	Poster Snapper Kit, Unprinted/Clear
	SNZ-POSNP-30-48-G-KIT	Poster Snapper Kit, Printed

	ITEM #	DESCRIPTION
36" W 24" H	SNZ-POSNP-36-24-CP-KIT	Poster Snapper Kit, Unprinted/Clear
	SNZ-POSNP-36-24-G-KIT	Poster Snapper Kit, Printed
36" W 30" H	SNZ-POSNP-36-30-CP-KIT	Poster Snapper Kit, Unprinted/Clear
	SNZ-POSNP-36-30-G-KIT	Poster Snapper Kit, Printed
36" W 36" H	SNZ-POSNP-36-36-CP-KIT	Poster Snapper Kit, Unprinted/Clear
	SNZ-POSNP-36-36-G-KIT	Poster Snapper Kit, Printed
36" W 48" H	SNZ-POSNP-36-48-CP-KIT	Poster Snapper Kit, Unprinted/Clear
	SNZ-POSNP-36-48-G-KIT	Poster Snapper Kit, Printed
48" W 24" H	SNZ-POSNP-48-24-CP-KIT	Poster Snapper Kit, Unprinted/Clear
	SNZ-POSNP-48-24-G-KIT	Poster Snapper Kit, Printed
48" W 30" H	SNZ-POSNP-48-30-CP-KIT	Poster Snapper Kit, Unprinted/Clear
	SNZ-POSNP-48-30-G-KIT	Poster Snapper Kit, Printed
48" W 36" H	SNZ-POSNP-48-36-CP-KIT	Poster Snapper Kit, Unprinted/Clear
	SNZ-POSNP-48-36-G-KIT	Poster Snapper Kit, Printed
48" W 48" H	SNZ-POSNP-48-48-CP-KIT	Poster Snapper Kit, Unprinted/Clear
	SNZ-POSNP-48-48-G-KIT	Poster Snapper Kit, Printed

MODULATE SNEEZE GUARD WALLS



easy to wipe clean and disinfect!

- lightweight and portable sneeze guard/protection/divider walls
- assembled dimensions = 36" w x 92.2" h x 15.7" d
- easy to wipe clean with disinfectant spray
- magnetic frames connect easily and can be positioned at various angles
- aluminum frame with snap buttons, offered magnetized or non

- 3 "infill" options available:
 - 3mm clear plexiglass (plex) top & bottom
 - 3mm clear plex top & opaque white 3mm PVC
 - opaque white 3mm PVC
- clear plex and PVC offered blank or printed
- artwork prints directly on the plex & PVC
- artwork on plex prints single-sided
- artwork on PVC prints single or double-sided

BUILD YOUR OWN



1

PICK YOUR FRAME SIZE & TYPE

ITEM #
1X1 FRAMES
MOD-SNZ-1-F
MOD-SNZ-2-F
MOD-SNZ-3-F
MOD-SNZ-4-F
1X2 FRAMES
MOD-SNZ-5-F
MOD-SNZ-6-F
MOD-SNZ-7-F
MOD-SNZ-8-F
MOD-SNZ-9-F
MOD-SNZ-10-F
2X1 FRAMES
MOD-SNZ-11-F
MOD-SNZ-12-F
MOD-SNZ-13-F
MOD-SNZ-14-F
2X2 FRAMES
MOD-SNZ-15-F
MOD-SNZ-16-F
MOD-SNZ-17-F
MOD-SNZ-18-F



2

PICK YOUR PANEL SIZE & TYPE

ITEM #	PANELS
MOD-SNZ-PLX-SM	Unprinted 3mm Plex - 3x3
MOD-SNZ-PLX-MED	Unprinted 3mm Plex - 3x4
MOD-SNZ-PLX-LG	Unprinted 3mm Plex - 4x4
MOD-SNZ-PVC-SM	Unprinted 3mm Sintra - 3x3
MOD-SNZ-PVC-SM	Unprinted 3mm Sintra - 3x4
MOD-SNZ-PVC-LG	Unprinted 3mm Sintra - 4x4
MOD-SNZ-1-PLEX-3-G	Printed 3mm Plex - 3x3
MOD-SNZ-2-PLEX-3-G / MOD-SNZ-3-PLEX-3-G	Printed 3mm Plex - 3x4
MOD-SNZ-4-PLEX-3-G	Printed 3mm Plex - 4x4
MOD-SNZ-1-PVC-3-G	Single-Sided Printed 3mm Sintra - 3x3
MOD-SNZ-2-PVC-3-G / MOD-SNZ-3-PVC-3-G	Single-Sided Printed 3mm Sintra - 3x4
MOD-SNZ-4-PVC-3-G	Single-Sided Printed 3mm Sintra - 4x4
MOD-SNZ-1-PVC-3-GDBL	Double-Sided Printed 3mm Sintra - 3x3
MOD-SNZ-2-PVC-3-GDBL / MOD-SNZ-3-PVC-3-GDBL	Double-Sided Printed 3mm Sintra - 3x4
MOD-SNZ-4-PVC-3-GDBL	Double-Sided Printed 3mm Sintra - 4x4



add wheels!

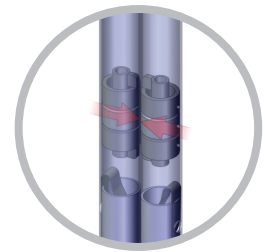

add high-powered internal magnets!

3

ADD WHEELS AND/OR MAGNETS

ITEM #
WHEELS (SET OF 4) + MOUNTING HARDWARE
CASTER-NUT-4
MAGNETS
MOD-SNZ-ADD-MAGNETS

can print single or double-sided



WARNING: Cancer
www.P65Warnings.ca.gov



MODULATE SNEEZE GUARD WALLS

CLEAR PLEXIGLASS KITS



MOD-SNZ-1
33"w x 33"h



MOD-SNZ-2
33"w x 47"h



MOD-SNZ-3
47"w x 33"h



MOD-SNZ-4*
47"w x 47"h



MOD-SNZ-5
33"w x 64.5"h



MOD-SNZ-6
33"w x 78.5"h



MOD-SNZ-7
33"w x 92"h



MOD-SNZ-8
47"w x 64.5"h



MOD-SNZ-9*
47"w x 78.5"h



MOD-SNZ-10*
46"w x 92"h



MOD-SNZ-11
64.5"w x 33"h



MOD-SNZ-12
64.5"w x 47"h



MOD-SNZ-13
92"w x 33"h



MOD-SNZ-14*
92"w x 47"h



MOD-SNZ-15
64.5"w x 78.5"h



MOD-SNZ-16
92"w x 64.5"h



MOD-SNZ-17*
92"w x 78.5"h



MOD-SNZ-18*
92"w x 92"h

*ideal for schools, offices,
beauty/barber shops & more!*

*due to plexiglass panel size(s), unit ships freight
**if adding wheels, 2 sets are required.

PERSONAL, FOLDABLE SNEEZE GUARDS



MENU-STYLE PERSONAL SNEEZE GUARD

- 20-21" w x 18.25" h x 10" d
- faux, leather-bound, personal foldable sneeze guard
- clear, transparent PVC plastic
- metal corners help add weight and stability
- folds down and packs easily
- to clean, use a plastic cleaner or mild detergent and water with a soft cloth
- pricing does not include individual packing, handling or multi-ship locations
- orders are bulk packaged

ITEM #	DESCRIPTION
DSKTP-TRIFLD-SNZ-GRD	Faux, Leather-bound, personal, foldable sneeze guard

maintain social distance in classrooms!

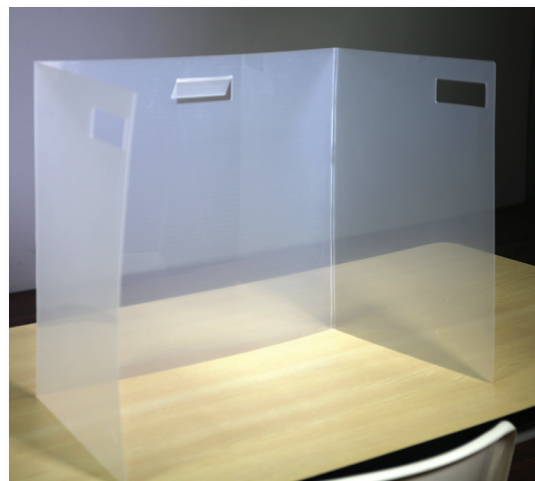

SEMI-TRANSPARENT PERSONAL SNEEZE GUARDS



- 22" w x 18" h x 13.5" d
- personal, foldable sneeze guard
- strengthened polypropylene with ribbing (not 100% transparent)
- full version features handle cut-outs on center, right and left sides
- elbow cut-out version includes handles and openings for elbows; cut-out for elbows is 6.75" w x 6.75" h
- folds down and packs easily
- to clean, use a plastic cleaner or mild detergent and water with a soft cloth
- pricing does not include individual packing, handling or multi-ship locations
- orders are bulk packaged

ITEM #	DESCRIPTION
DSKTP-TRIFLD-DOM	Full size, semi-transparent, foldable sneeze guard
DSKTP-TRIFLD-DOM-CT	Elbow cut-out, semi-transparent foldable sneeze guard

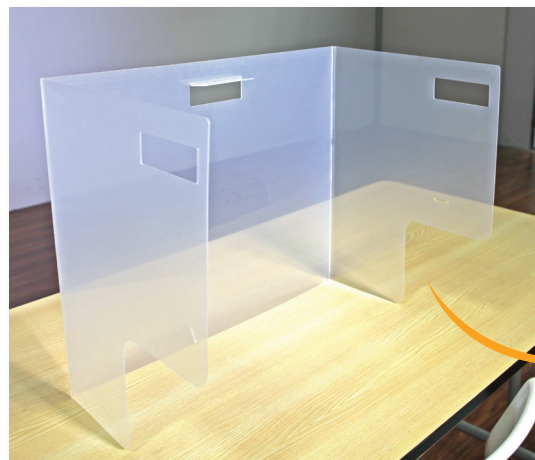

elbow cut-outs for easy arm placement

PERSONAL, FOLDABLE SNEEZE GUARDS

ECONOMY PERSONAL DESKTOP SNEEZE GUARD

- 20-21" w x 18" h x 11" d
- economy, personal, foldable sneeze guard
- clear, transparent PETG plastic (thermoplastic polyester) w/ removeable film
- flaps adhere to desktop with hook & loop strips (included)
- to clean, use a plastic cleaner or mild detergent and water with a soft cloth
- lead time: 15-20 days
- sold in large quantities only; minimum order quantity: 1,000

ITEM #	DESCRIPTION
DSKTP-TRIFLD-GRD	Economy, clear foldable sneeze guard

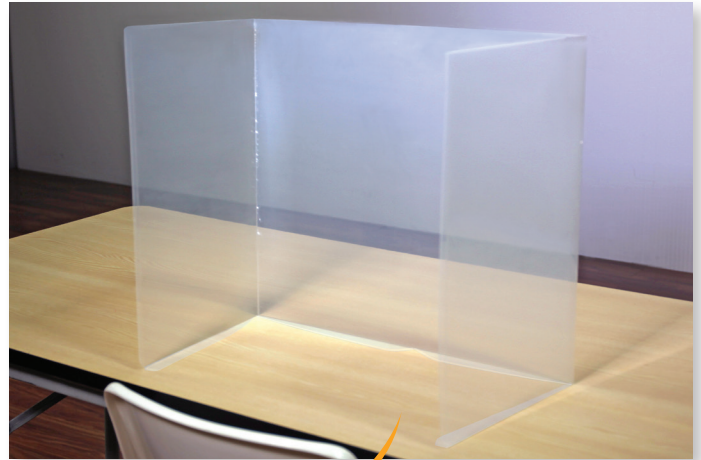

call to order a sample!



FLATPACK SNEEZE GUARD



- 1/8" thick desktop/tabletop sneeze guard
- 22" wide
- choice of height: 18", 23.5", 31"
- no minimum order quantity
- quantities of ten or less ship next day
- made in USA

ITEM #	DESCRIPTION
SNZ-TRIFLD-22x18x12	Flatpack Sneeze Guard 22"w x 18"h x 12"d
SNZ-TRIFLD-22x23.5x12	Flatpack Sneeze Guard 22"w x 23.5"h x 12"d
SNZ-TRIFLD-22x31x12	Flatpack Sneeze Guard 22"w x 31"h x 12"d

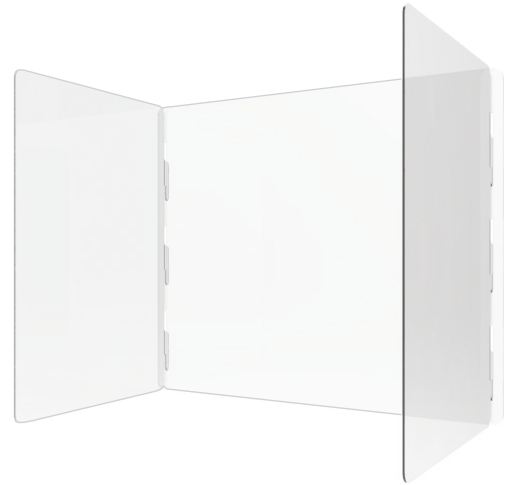

4-WAY DESKTOP SNEEZE GUARD



- 4-way desktop/tabletop sneeze guard made of clear plexiglass
- interlocking design provides structural stability without the need for hardware
- 1/4" thick desktop/tabletop sneeze guard
- 47" w x 23.5" h x 47" d
- made in North America
- packs flat for easy storage
- UPS/FedEx shippable

ITEM #	DESCRIPTION
SNZ-X-DVDR	Clear, 4-way plexiglass divider

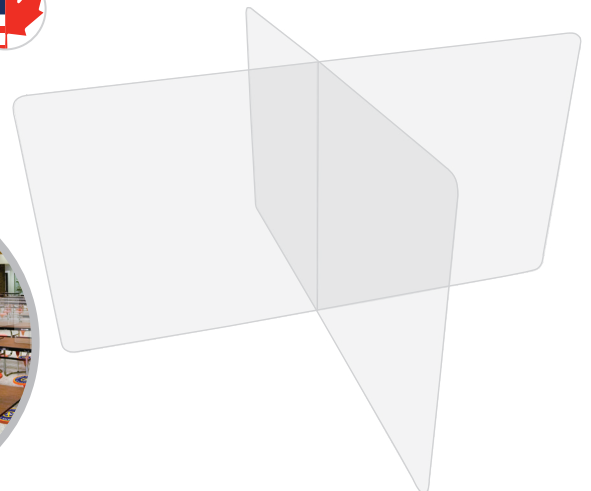

CUBICLE DIVIDERS, PROTECTION WALLS & BARRIERS

CUBICLE DIVIDERS

- clear, 6mm thick plexiglass dividers held in place by 3mm PVC clamps that attach to cubicle
- plexiglass dividers offered off-the-shelf in three sizes:
 - 23.5" w x 23.5" h
 - 47.5" w x 23.5" h
 - 35.5" w x 23.5" h
- custom plexiglass sizes also available maximum 95.5" w x 35.5" h
- kits include clear plexiglass divider & PVC clamps to hold plexiglass in place
- plexiglass features rounded radius on corners
- clamps are adjustable and span widths from 1" - 2.5"



ITEM #	DESCRIPTION
SNZ-ADJ-2x2	23.5" w x 23.5" h 6mm Plexiglass Sneeze Guard with Adjustable Sintra Clamps
SNZ-ADJ-3x2	35.5" w x 23.5" h 6mm Plexiglass Sneeze Guard with Adjustable Sintra Clamps
SNZ-ADJ-4x2	47.5" w x 23.5" h 6mm Plexiglass Sneeze Guard with Adjustable Sintra Clamps
SNZ-ADJ-CUS-SM	CUSTOM up to 47.5" w x 23.5" h 6mm Plexiglass Sneeze Guard with Adjustable Sintra Clamps
SNZ-ADJ-CUS-MED	CUSTOM up to 47.5" w x 35.5" h 6mm Plexiglass Sneeze Guard with Adjustable Sintra Clamps
SNZ-ADJ-CUS-LG	CUSTOM up to 95.5" w x 35.5" h 6mm Plexiglass Sneeze Guard with Adjustable Sintra Clamps



KIOSK DIVIDER

- 38.15" w x 71.5" h x 11.81" d kiosk dividers, perfect to place in between check in stations in air terminals, ATM machines, gaming machines, restroom sinks and more
- dividers include 6mm clear plexiglass panels
- frame is lightweight aluminum extrusion
- heavy-duty steel base ensures stability

ITEM #	DESCRIPTION
SNZ-KIOSK-DIVIDER-1800	Extrusion, Plexiglass Kiosk, Machine Divider

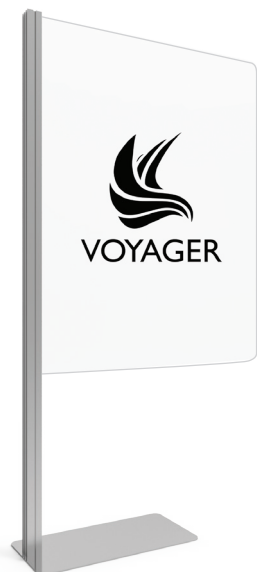

DESKTOP SNEEZE GUARDS

- clear, 1/8" (3mm) thick plexiglass dividers held in place by 15mm extrusion that sits on desk
- frame is lightweight anodized aluminum extrusion
- plexiglass dividers offered off-the-shelf in four sizes:
 - 24" w x 24" h with two 12" returns/side panels
 - 36" w x 24" h with two 12" returns/side panels
 - 48" w x 24" h with two 12" returns/side panels
 - 60" w x 24" h with two 24" returns/side panels

ITEM #	DESCRIPTION
DSKTP-SNZ-2x2x1	24" w x 24" h 3mm Plexiglass Divider with two 12" Side Panels
DSKTP-SNZ-3x2x1	36" w x 24" h 3mm Plexiglass Divider with two 12" Side Panels
DSKTP-SNZ-4x2x1	48" w x 24" h 3mm Plexiglass Divider with two 12" Side Panels
DSKTP-SNZ-5x2x2	60" w x 24" h 3mm Plexiglass Divider with two 24" Side Panels



WARNING: Cancer
www.P65Warnings.ca.gov

CUBICLE DIVIDERS, PROTECTION WALLS & BARRIERS

WORKSTATION DIVIDER

- 47" w x 48" h x 15.75" d workstation dividers, perfect for offices, computer labs, libraries
- frame is 2" wide; foot is 15.75"
- adjustable knob ensures the hitch wall reaches the desktop sufficiently
- dividers include 1/8" clear plexiglass panels
- frame is lightweight aluminum extrusion

ITEM #	DESCRIPTION
HITCH-WALL-1	Extrusion, Plexiglass Workstation Divider

adjustable knob allows for secure placement



CUSTOM BARRIER WALLS FOR OFFICES

Work with us to customize and tailor your return to office needs. We offer table-top dividers/protectors, divider walls to place in between workstations, sliding, modular protection barriers and more. We offer many different sizes, all offered with clear plexiglass panels and your choice of aluminum feet or casters.

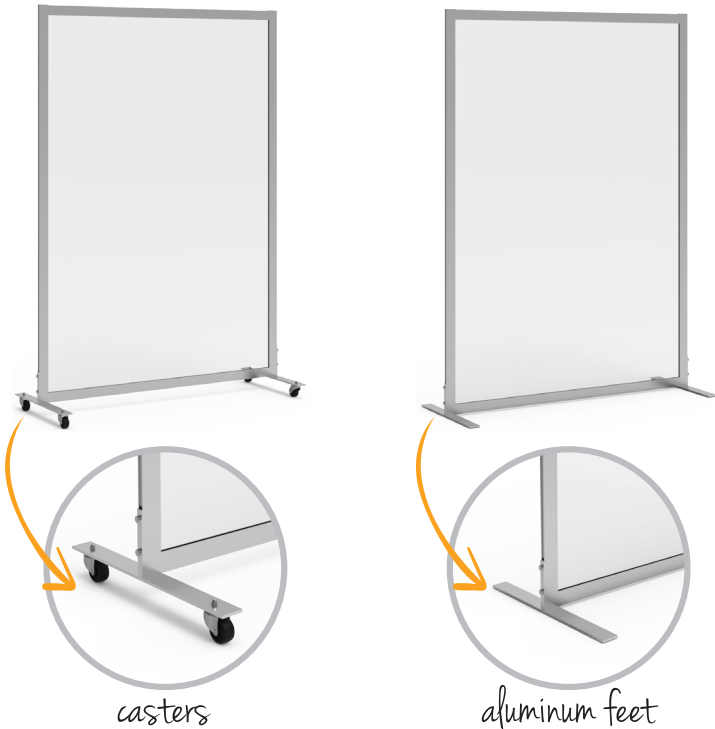

casters

aluminum feet



*get an estimate started today
for your office environment*



WARNING: Cancer
www.P65Warnings.ca.gov

STOCK & CUSTOM PRINTED MASKS





ADULT MASKS



FITTED ADULT MASK



PLEATED ADULT MASK



MASK SPECIFICATIONS

- 100% professionally made in the USA
- double-layered protection against dust, pollen, exhaust emissions, passive smoking fog vapor and moisture droplets
- antimicrobial fabric inhibits the penetration and growth of germs & bacteria
- **fitted mask** features outer layer of breathable polyester and inner layer of cotton
- **pleated mask** features two layers of breathable polyester with a pocket for a filter (filter not included)
- high quality, high-definition printed graphics
- tested and compliant with CPSIA guidelines for children's product safety
- machine washable and reusable
- pack of 3 of the same style & design for stock patterns only
- ear loops are soft elastic straps
- comfort fit, expandable & breathable, contours your face and reduces eyeglass fogging
- unisex, one size fits most
- meets CDC recommendations for public face coverings
- this mask is not intended for medical use
- no returns on masks due to the nature of this product
- all masks should be machine washed before wearing

STOCK PATTERN

ADULT STOCK PRINTED

- 3 Pack (1x Pack of 3)
- 9 (3x Pack of 3)
- 18 (6x Pack of 3)
- 60 (20x Pack of 3)
- 120 (40x Pack of 3)
- 360 (120x Pack of 3)
- 720 (240x Pack of 3)

*3-pack is based on the same style & design. Cannot mix & match.

CUSTOM-PRINTED MASKS

ADULT CUSTOM PRINTED

- 50 masks (minimum order qty)
- 51 to 500 masks
- 501 to 1,000 masks
- 1,001 to 2,500 masks
- 2,501 to 5,000 masks
- 5,001+ masks

customize!

ADD YOUR LOGO OR DESIGN



made in the USA!



antimicrobial fabric!

ADULT MASKS

STOCK PATTERNS



01: white daisy



02: cool metal



03: flower power



04: geo violet



05: bunch of roses



06: zebra



07: zebra color



08: leopard



09: camo black/white



10: camo



11: American flag



12: Chicago flag



13: America strong



14: stars & stripes



15: stars



16: music



17: flamingo



18: donuts



19: watermelon



20: ice cream



21: sunglasses



22: lips



23: rainbow



24: blue black stripes



25: blue stripes



26: chevron white



27: chevron rainbow

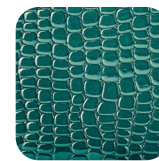

28: teal snake skin

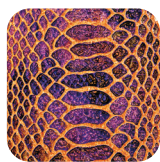

29: bright snake skin



30: floral



31: smiles



32: emojis



33: pandas



34: princess bear



35: shamrocks

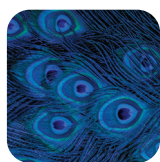

36: blue peacock



37: green fish

pick a number & style
ADULT SIZE FITTED OR PLEATED



CHILD MASKS



YOUTH PLEATED MASK

made in the USA!

promote school spirit & customize with a school logo!



CUSTOM YOUTH PLEATED CHILD MASK

MASK SPECIFICATIONS

- 100% professionally made in the USA
- double-layered protection against dust, pollen, exhaust emissions, passive smoking fog vapor and moisture droplets
- antimicrobial fabric inhibits the penetration and growth of germs & bacteria
- **pleated mask** features two layers of breathable polyester with a pocket for a filter (filter not included)
- tested and compliant with CPSIA guidelines for children's product safety
- high quality, high-definition printed graphics
- machine washable and reusable
- pack of 3 of the same style & design for stock patterns only
- soft elastic can be tied (and cut) to fit each child appropriately
- comfort fit, expandable & breathable
- contours your face and reduces eyeglass fogging
- youth size recommended for children ages 5-11; adult size recommended for pre-teen (12+)
- meets CDC recommendations for public face coverings
- this mask is not intended for medical use
- no returns on masks due to the nature of this product
- all masks should be machine washed before wearing

STOCK PATTERN

ADULT STOCK PRINTED
3 Pack (1x Pack of 3)
9 (3x Pack of 3)
18 (6x Pack of 3)
60 (20x Pack of 3)
120 (40x Pack of 3)
360 (120x Pack of 3)
720 (240x Pack of 3)

*3-pack is based on the same style & design. Cannot mix & match.

CUSTOM-PRINTED MASKS

ADULT CUSTOM PRINTED
50 masks (minimum order qty)
51 to 500 masks
501 to 1,000 masks
1,001 to 2,500 masks
2,501 to 5,000 masks
5,001+ masks

YOUTH STOCK PATTERNS



04: geo violet



14: stars & stripes



18: donuts

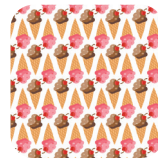

20: ice cream



23: rainbow



24: blue black stripes



31: smiles



32: emojis



33: pandas



34: princess bear

SOCIAL DISTANCING CHAIR COVERS & FLOOR DECALS



SOCIAL DISTANCING CHAIR COVERS

STOCK DESIGNS

- graphic wraps over the top of the chair; white elastic stretches around the sides
- two material options available: Fabric (Display Polyester) & Outdoor Vinyl (Outdoor Scrim)
- outdoor vinyl chair cover is easy to wipe down and disinfect; fabric chair cover is machine washable
- 3 sizes available: Small 12" w x 12" h (12" w x 6" h per side), Medium 12" w x 24" h (12" w x 12" h per side) and Large 18" w x 24" h (18" w x 12" h per side)
- stock options and custom-designed chair covers offered
- all sizes available in packs of 8

encourage social distancing!

SCHOOLS, STADIUMS, BARS CAFÉS,
RESTAURANTS, POOLSIDE AND MORE



WHITE_THANKYOU



GRAY_NOSEATING



BLUE_6FTREMINDER

ITEM #	FABRIC CHAIR COVER PRINTED ON 40Z. DISPLAY POLYESTER SEWN WITH ELASTIC ON BOTH SIDES	SOLD IN PACKS OF
CHAIR-COVER-S-G-DP	12" w x 12" h Small Graphic (12" x 6" per side)	8
CHAIR-COVER-M-G-DP	12" w x 24" h Medium Graphic (12" x 12" per side)	8
CHAIR-COVER-L-G-DP	18" w x 24" h Large Graphic (18" x 12" per side)	8
ITEM #	VINYL CHAIR COVERS PRINTED ON 180Z. OUTDOOR SCRIM SEWN WITH ELASTIC ON BOTH SIDES	SOLD IN PACKS OF
CHAIR-COVER-S-G-OB18	12" w x 12" h Full Graphic (12" x 6" per side)	8
CHAIR-COVER-M-G-OB18	12" w x 24" h Full Graphic (12" x 12" per side)	8
CHAIR-COVER-L-G-OB18	18" w x 24" h Full Graphic (18" x 12" per side)	8

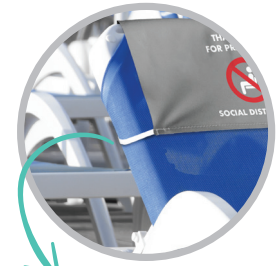

white elastic tightly secures chair cover

CUSTOM DESIGNS

ITEM #	FABRIC CHAIR COVER PRINTED ON 40Z. DISPLAY POLYESTER SEWN WITH ELASTIC ON BOTH SIDES	SOLD IN PACKS OF
CHAIR-COVER-S-CUS-G-DP	12" w x 12" h Full Graphic (12" x 6" per side)	8
CHAIR-COVER-M-CUS-G-DP	12" w x 24" h Full Graphic (12" x 12" per side)	8
CHAIR-COVER-L-CUS-G-DP	18" w x 24" h Full Graphic (18" x 12" per side)	8
ITEM #	VINYL CHAIR COVERS PRINTED ON 180Z. OUTDOOR SCRIM SEWN WITH ELASTIC ON BOTH SIDES	SOLD IN PACKS OF
CHAIR-COVER-S-CUS-G-OB18	12" w x 12" h Full Graphic (12" x 6" per side)	8
CHAIR-COVER-M-CUS-G-OB18	12" w x 24" h Full Graphic (12" x 12" per side)	8
CHAIR-COVER-L-CUS-G-OB18	18" w x 24" h Full Graphic (18" x 12" per side)	8

customize!

WITH YOUR LOGO OR DESIGN



REMOVABLE WALL & WINDOW VINYL DECALS



PEEL & STICK SIGNS

- minimum order quantity: 5 signs
- offered in 3 sizes:
 - small, 6" w x 6" h
 - medium, 12" w x 12" h
 - large, 18" w x 18" h
- 6mil white matte, peel & stick, repositionable vinyl
- intended for smooth, indoor wall surfaces

ITEM #
G-W-RMV-AVP-6X6
G-W-RMV-AVP-12X12
G-W-RMV-AVP-18X18

communicate important messages!

CIRCULAR PEEL & STICK SIGNS



MASKS REQUIRED 1



MASKS REQUIRED 2

TEMP CHECK 1

TEMP CHECK 2

TEMP CHECK 3

•thank you•

HANDWASHING 1

HANDWASHING 2

WE ARE OPEN 1

SQUARE W/ ROUND CORNER PEEL & STICK SIGNS



SOCIAL DISTANCE 1



SOCIAL DISTANCE 2

SOCIAL DISTANCE 3

SOCIAL DISTANCE 4

HANDWASHING 3

PLEASE WASH YOUR HANDS

HANDWASHING 4

WE ARE OPEN 2

WE ARE OPEN 3

WE ARE OPEN 4



REMOVABLE WALL & WINDOW VINYL DECALS

RECTANGULAR PEEL & STICK SIGNS

- minimum order quantity: 5 signs
- offered in 3 sizes:
 - small, 5" w x 7" h / 7" w x 5" h
 - medium, 8" w x 10" h / 10" w x 8" h
 - large, 10" w x 15" h / 15" w x 10" h
- 6mil white matte, peel & stick, repositionable vinyl
- intended for smooth, indoor wall surfaces

ITEM #
G-W-RMV-AVP-5X7
G-W-RMV-AVP-8X10
G-W-RMV-AVP-10X15

repositionable vinyl

VERTICAL DESIGNS



MASKS REQUIRED 4

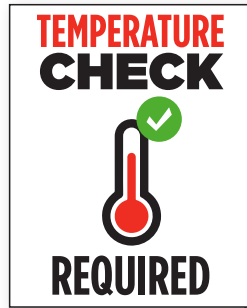

TEMP CHECK 4



WE ARE OPEN 5



HORIZONTAL DESIGNS



MASKS REQUIRED 5

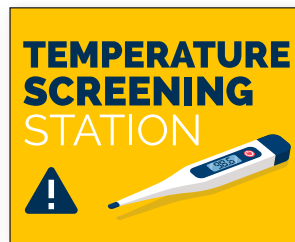

TEMP CHECK 5



SOCIAL DISTANCE 5



WE ARE OPEN 5



MASKS REQUIRED 3

ITEM #
G-W-RMV-AVP-9X3
G-W-RMV-AVP-18X6

SOCIAL DISTANCING CHAIR COVERS & FLOOR DECALS

SOCIAL DISTANCING FLOOR DECALS



FOOTPRINT FLOOR DECALS

- circular adhesive vinyl stickers, contour cut
- matte surface is slip resistant & scratch resistant
- clean gently with a mild dish soap and water
- offered in red, orange, blue, green, yellow and purple
- footprints offered in sets of 10, any color
- custom designs also available

ITEM #	DESCRIPTION
G-W-FLR-AVP-12D	Social Distance Sign 12" x 12"
G-W-FLR-AVP-18D	Social Distance Sign 18" x 18"
G-W-FLR-AVP-24D	Social Distance Sign 24" x 24"
G-W-FLR-AVP-36D	Social Distance Sign 36" x 36"
G-W-FLR-AVP-FP-10	Footprint - Any Color



6' APART FLOOR DECALS

- circular adhesive vinyl stickers, contour cut
- matte surface is slip resistant & scratch resistant
- clean gently with a mild dish soap and water
- custom designs also available

ITEM #	DESCRIPTION
G-W-FLR-AVP-12D-6APART	6ft Apart Circle 12" x 12"
G-W-FLR-AVP-18D-6APART	6ft Apart Circle 18" x 18"
G-W-FLR-AVP-24D-6APART	6ft Apart Circle 24" x 24"
G-W-FLR-AVP-36D-6APART	6ft Apart Circle 36" x 36"

*perfect for schools,
businesses, stores and more!*

SOCIAL DISTANCING FLOOR DECALS



AISLEWAY TRAFFIC FLOW FLOOR DECAL KIT

- kit includes one of each rectangular sign & 10 arrows
- adhesive vinyl stickers, contour cut
- rectangular signs are 18" w x 12" h
- arrow signs are 6" w x 8" h
- custom designs also available

ITEM #	DESCRIPTION
AISLE-DIR-KIT-GFX	Aisle Direction Kit

guide traffic!



BE SMART & CUSTOMIZABLE FLOOR DECALS

- adhesive vinyl stickers, contour cut
- 12", 18", 24" and 36" square sign options
- custom designs also available

ITEM #	DESCRIPTION
G-W-FLR-AVP-12X12-BESMART	Be Smart Square Sign 12" x 12"
G-W-FLR-AVP-18X18-BESMART	Be Smart Square Sign 18" x 18"
G-W-FLR-AVP-24X24-BESMART	Be Smart Square Sign 24" x 24"
G-W-FLR-AVP-36X36-BESMART	Be Smart Square Sign 36" x 36"
G-W-FLR-AVP-12X12-CUS-LOGO	Customer Logo Sign 12" x 12"
G-W-FLR-AVP-18X18-CUS-LOGO	Customer Logo Sign 18" x 18"
G-W-FLR-AVP-24X24-CUS-LOGO	Customer Logo Sign 24" x 24"
G-W-FLR-AVP-36X36-CUS-LOGO	Customer Logo Sign 36" x 36"

your logo or design here!

slip & scratch resistant!



ONE-WAY AISLE ARROW FLOOR DECAL

- adhesive vinyl, contour cut
- 8.75" w x 12" h
- color combinations are flexible

ITEM #	DESCRIPTION
G-W-FLR-AVP-LRG-ARROW	One-Way Contour Arrow

custom options available!

OUTDOOR CURBSIDE SIGNS, FLAGS & BANNERS



OUTDOOR CURBSIDE SIGNS, FLAGS & BANNERS

ZOOM™ FLEX FLAGS

- can be used indoors or outdoors
- comes in four shapes: teardrop, feather, straight & edge
- graphic rotates in wind
- water ring base support adds stability to cross base (optional upgrades)
- includes ground stake only

graphic printed on flag material



zoom fiber poles provide ultimate flexibility

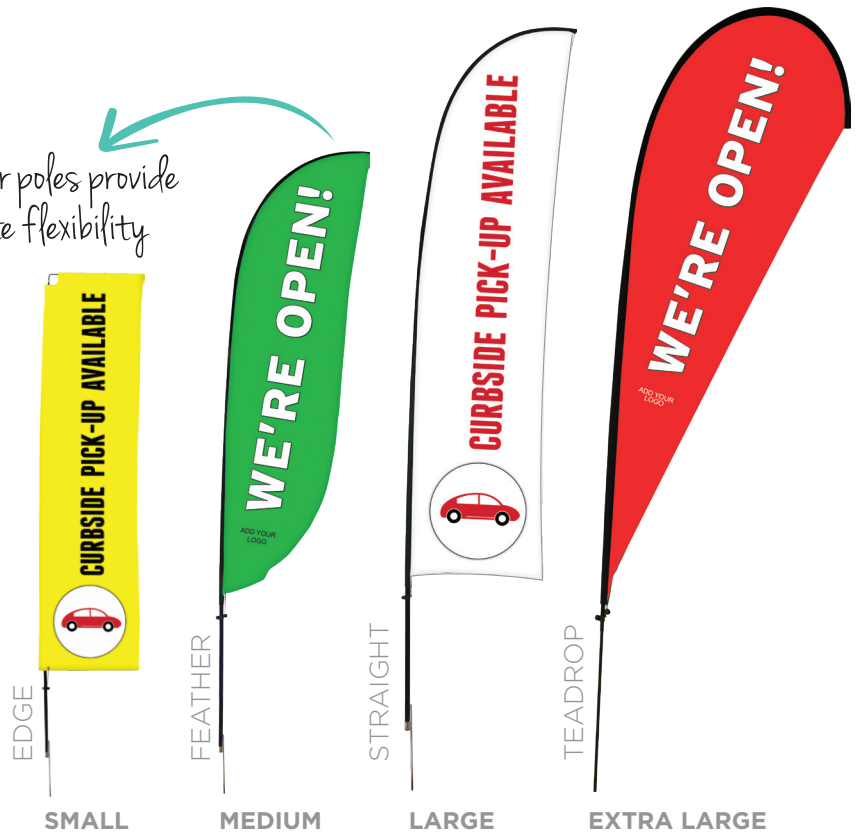

ITEM #	DESCRIPTION
P02A0024	Small Teardrop Single-Sided Graphic Kit
ZOOM-FLX-SM	Hardware only
P02A0026	Small Feather Single-Sided Graphic Kit
ZOOM-FLX-SM	Hardware only
P02A0028	Small Straight Single-Sided Graphic Kit
ZOOM-FLX-SM	Hardware only
P02A0030	Small Edge Single-Sided Graphic Kit
ZOOM-FLX-SM-E	Hardware only
P02A0032	Medium Teardrop Single-Sided Graphic Kit
ZOOM-FLX-M	Hardware only
P02A0034	Medium Feather Single-Sided Graphic Kit
ZOOM-FLX-M	Hardware only
P02A0036	Medium Straight Single-Sided Graphic Kit
ZOOM-FLX-M	Hardware only
P02A0038	Medium Edge Single-Sided Graphic Kit
ZOOM-FLX-M-E	Hardware only
P02A0040	Large Teardrop Single-Sided Graphic Kit
ZOOM-FLX-LG	Hardware only
P02A0042	Large Feather Single-Sided Graphic Kit
ZOOM-FLX-LG	Hardware only
P02A0044	Large Straight Single-Sided Graphic Kit
ZOOM-FLX-LG	Hardware only
P02A0046	Large Edge Single-Sided Graphic Kit
ZOOM-FLX-LG-E	Hardware only
P02A0048	Extra Large Teardrop Single-Sided Graphic Kit
ZOOM-FLX-XL-2	Hardware only
P02A0050	Extra Large Feather Single-Sided Graphic Kit
ZOOM-FLX-XL-2	Hardware only
P02A0052	Extra Large Straight Single-Sided Graphic Kit
ZOOM-FLX-XL-2	Hardware only
P02A0054	Extra Large Edge Single-Sided Graphic Kit
ZOOM-FLX-XL-E	Hardware only

*kits include hardware & single-sided graphic

ZOOM FLAG BASES



ITEM #	DESCRIPTION
ZOOM-FLX-FB	Fillable Ground Base
ZOOM-FLX-STCK-BASE	Stackable Base
ZOOM-FLX-CB	Cross Base
ZOOM-FLX-WR	Water Ring Base Support
ZOOM-FLX-SQ	Square Steel Base
ZOOM-FLX-AGR	Auger Base
ZOOM-FLX-DO	Drive-Over Base



All Outdoor products have a one year limited frame warranty and are eco-friendly.

OUTDOOR CURBSIDE SIGNS, FLAGS & BANNERS

WIND DANCER MINI



- adjustable graphic height = up to 6'
- hollow base can be filled with either water or sand
- optional carry bag

ITEM #	DESCRIPTION
P02A0056	Wind Dancer Mini Single-Sided Graphic Kit
WIND-MIN	Hardware only

*kits include hardware & graphic



WIND DANCER LT

- adjustable graphic height = up to 8'8"
- hollow base can be filled with either water or sand
- optional carry bag

ITEM #	DESCRIPTION
P02A0060	Wind Dancer LT Single-Sided Long Graphic Kit
WIND-LT	Hardware only

*kits include hardware & graphic



heavy duty water/sand fillable bases



All Outdoor products have a one year limited hardware warranty and are eco-friendly.

OUTDOOR CURBSIDE SIGNS, FLAGS & BANNERS

BLIZZARD

- min width x max height: 23.5"w x 80"h
- outdoor banner stand
- outdoor scrim vinyl graphic material
- easy grommet graphic attachment



fill the base with water or sand

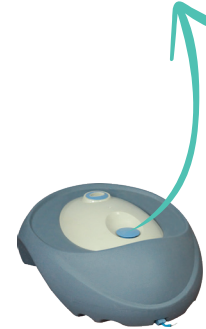

ITEM #	DESCRIPTION
P02A0065	23.5"w x 80"h Single-Sided Custom Graphic Kit
BLZD	Hardware only

*kits include hardware & graphic

THUNDER

- visual graphic area = approx. 33.5"w x 78.75"h
- double-sided outdoor retractable banner stand
- large twist-lock feet
- stakes included to secure to ground
- snap-top graphic rail
- 3-piece bungee pole
- outdoor scrim vinyl graphic material



stakes included to secure in the grass!

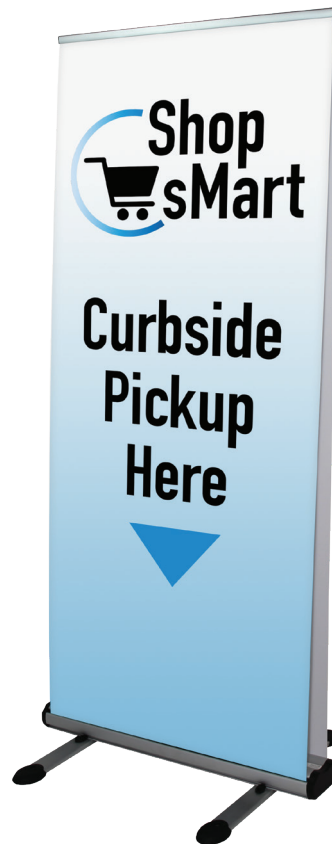

heavy-duty outdoor retractable banner stand



ITEM #	DESCRIPTION
P02A0068	Banner Stand Hardware, Two Scrim Vinyl Custom Graphics, Carry Bag
THUNDER-1	Hardware only

*kits include hardware & graphic



All Outdoor products have a one year limited frame warranty and are eco-friendly.

OUTDOOR CURBSIDE SIGNS, FLAGS & BANNERS

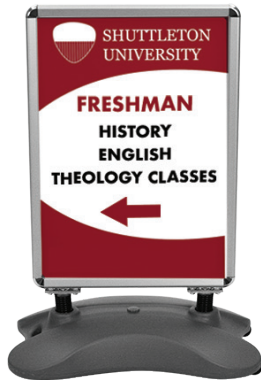

includes wheels for ease of moving!



NEW

WHIRLWIND

- 30.75" w x 44.12" h x 19.5" d
- front-loading snap frames constructed from aluminum & powder-coated steel
- single or double-sided PVC graphics
- includes clear lens cover
- dual-spring design flexes to withstand wind gusts
- compact durable base can be filled with water or sand for extra stability
- integrated wheel set

ITEM #	DESCRIPTION
P02A0069	Single-Sided Graphic Kit
P02A0070	Double-Sided Graphic Kit
WHRL-WND-2	Hardware only

*kits include hardware & graphic

ACE-ECO

- foldable, economy aluminum A-frame sign
- can be used outdoors and indoors
- choice of 6mm PVC rigid board(s) and/or dry-erase board(s) that slides in at the top of each side
- assembled dimensions: 25.63" w x 32.5" h x 19.75" d
- simply open frame, position arms into place and slide boards into frame

ITEM #	DESCRIPTION
ACE-ECO-PVC-BOARD-1	ACE-ECO with (1) 6mm PVC Board
ACE-ECO-DRY-ERASE-BOARD-1	ACE-ECO with (1) 6mm Dry Erase Board
ACE-ECO-PVC-BOARD-2	ACE-ECO with (2) 6mm PVC Boards
ACE-ECO-DRY-ERASE-BOARD-2	ACE-ECO with (2) 6mm Dry Erase Boards
ACE-ECO-DRY-ERASE-PVC-KIT	ACE-ECO with (1) 6mm PVC Board & (1) 6mm Dry Erase Board
ACE-ECO	Hardware only

*kits include hardware & graphic

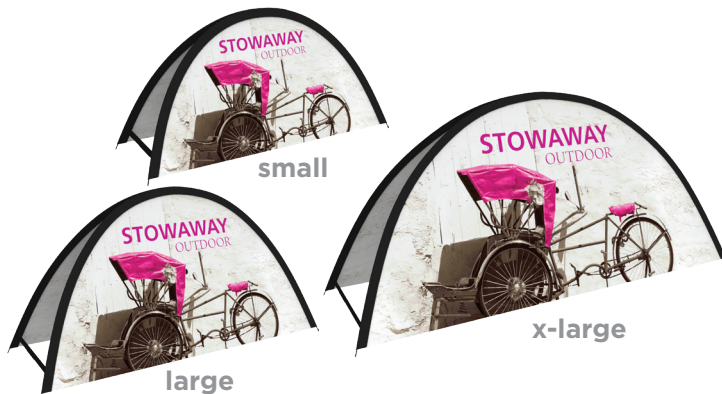

STOWAWAY

- lightweight, high visual impact display stand
- indoor/outdoor use
- carbon fiber poles easily assemble
- includes carry bag & 4 ground stakes
- no tools required
- custom printed graphics

ITEM #	DESCRIPTION
P02A0082	Small Stowaway Display
P02A0083	Large Stowaway Display
P02A0084	X-Large Stowaway Display

*kits include hardware & graphic



MONSOON

- visual graphic area = approx. 92.125" w x 32" h
- semi-portable single or double-sided billboard
- easy grommet graphic attachment
- includes ground stakes & bungee rope

ITEM #	DESCRIPTION
MONSN-2	Monsoon Billboard Frame, Bungee Cords, stakes, carry bag
MON-G	Monsoon Billboard Graphic, Scrim Vinyl

*kits include hardware & graphic



OUTDOOR CURBSIDE SIGNS, FLAGS & BANNERS

CONTOUR

- two printed graphics (front & back) available in six unique shapes
- choose from plate base or hollow, fillable base with dual-spring design to flex and withstand wind gusts
- hollow, fillable base can be filled with water or sand for added stability
- graphics easily secure to either base using hook & loop

ITEM #	DESCRIPTION
P02A0133	Contour Arrow Up, Plate Base - Single-Sided Kit
P02A0109	Contour Arrow Up, Plate Base - Double-Sided Kit
P02A0132	Contour Arrow Up, Water Base - Single-Sided Kit
P02A0110	Contour Arrow Up, Water Base - Double-Sided Kit
P02A0135	Contour Arrow Side, Plate Base - Single-Sided Kit
P02A0111	Contour Arrow Side, Plate Base - Double-Sided Kit
P02A0134	Contour Arrow Side, Water Base - Single-Sided Kit
P02A0112	Contour Arrow Side, Water Base - Double-Sided Kit
P02A0131	Contour Bottle, Plate Base - Single-Sided Kit
P02A0115	Contour Bottle, Plate Base - Double-Sided Kit
P02A0130	Contour Bottle, Water Base - Single-Sided Kit
P02A0116	Contour Bottle, Water Base - Double-Sided Kit
P02A0137	Contour Wave 1, Plate Base - Single-Sided Kit
P02A0113	Contour Wave 1, Plate Base - Double-Sided Kit
P02A0136	Contour Wave 1, Water Base - Single-Sided Kit
P02A0114	Contour Wave 1, Water Base - Double-Sided Kit
P02A0139	Contour Wave 2, Plate Base - Single-Sided Kit
P02A0119	Contour Wave 2, Plate Base - Double-Sided Kit
P02A0138	Contour Wave 2, Water Base - Single-Sided Kit
P02A0120	Contour Wave 2, Water Base - Double-Sided Kit
P02A0141	Contour Circle, Plate Base - Single-Sided Kit
P02A0117	Contour Circle, Plate Base - Double-Sided Kit
P02A0140	Contour Circle, Water Base - Single-Sided Kit
P02A0118	Contour Circle, Water Base - Double-Sided Kit

*kits include hardware & graphic



ARROW UP



ARROW SIDE



BOTTLE



WAVE 1

CHOOSE YOUR BASE

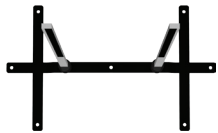

Plate Base

OR



Fillable Base



CIRCLE



WAVE 2



ACE-2

- visual graphic area = 28.87" w x 35" h
- double-sided aluminum A-frame sign holder with black plastic corner grips
- clear dry erase graphic lenses included
- front-loading snap frames for easy graphic swaps
- quick, toolless assembly

ITEM #	DESCRIPTION
P02A0105	Double-Sided Graphic Kit ACE-2 Hardware only

*kits include hardware & graphic



TWIRL

- 26.41" w x 79" h x 1" d
- lightweight, fiberglass rod frame
- double-sided pillowcase fabric graphic
- ground stake connection allows for twirl movement

ITEM #	DESCRIPTION
P02A0106	Frame, Double-Sided Pillowcase Fabric Graphics, Carry Bag
TWIRL	Hardware only

*kits include hardware & graphic

OUTDOOR CURBSIDE SIGNS, FLAGS & BANNERS



SWING SIGN

- visual graphic area = 19.63" w x 29.5" h
- double-sided graphic, printed on 6mm PVC
- black, steel portable sign with integrated wheeled base
- hollow plastic base can be filled with sand or water
- double-ring mounting system holds graphic in place while allowing it to swing

ITEM #	DESCRIPTION
P02A0107	Single-Sided Graphic Kit
P02A0108	Double-Sided Graphic Kit
SWING-SIGN	Hardware only

*kits include hardware & graphic



ATLAS

- outdoor sign holder (base only, sign not included)
- hollow plastic base that can be filled with water or sand
- securely holds a rigid graphic 0.4-0.5" thick or a Zoom outdoor flagpole
- recommended graphic substrates: 10mm corrugated plastic or 1/2" rigid substrates
- includes three ground stakes

ITEM #	DESCRIPTION
ATLAS	Hardware only

ZOOM FLEX TENT

- 10ft tall by 8.5ft wide
- comes with four fiberglass poles, ground stakes and single-sided printed canopy graphic
- assembled dimensions: 103" w x 112" h x 103" d
- assembles fast; two people recommended for assembly
- add a Zoom Stackable base for use in non-grassy areas
- withstands winds up to 15 MPH

ITEM #	DESCRIPTION
P02A0080	Single-Sided Printed Canopy Graphic Kit

*kits include hardware & graphic



overhead view



OUTDOOR CURBSIDE SIGNS, FLAGS & BANNERS

ZOOM FLEX BILLBOARD

- sturdy and flexible outdoor billboard made of a tubular frame & flexible fiberglass poles
- withstands winds up to 14 MPH
- assembled dimensions: 106" w x 78.74" h x 32" d
- single or double-sided mesh graphic; single sided comes with white backer
- comes with two circular bags that hold water to use as weights for stability
- packs in carry bag
- option to ship in box or OCB-2 case

ITEM #	DESCRIPTION
P02A0078	Single-Sided Graphic Kit w/ Box
P02A0121	Single-Sided Graphic Kit w/ Case
P02A0079	Double-Sided Graphic Kit w/ Box
P02A0122	Double-Sided Graphic Kit w/ Case
ZOOM-FLX-OD-BB	Hardware only w/ Box
ZOOM-FLX-OD-BB-OCB	Hardware only w/ Case

*kits include hardware & graphic



ZOOM FLEX ARCH

- arch-shaped outdoor flag/sign
- assembled dimensions: 114" w x 113.85" h x 1.75" d
- includes flexible fiber poles that feed into the black perimeter of the graphic
- custom printed flag graphic offered single-sided
- stakes keep the sign secure in ground
- add the Zoom Flex Stackable base for extra stability and height

ITEM #	DESCRIPTION
P02A0076	Single-Sided Graphic Kit
ZOOM-FLX-ARCH	Hardware only

*kits include hardware & graphic



add stackable bases for extra stability!



OUTDOOR HANGING BANNERS





OUTDOOR HANGING BANNERS

7 OZ. MESH VINYL SINGLE-SIDED

7 oz. mesh vinyl banners are ideal for a long-lasting outdoor display. Banners allow wind to stream through while maintaining vibrant colors and clear messaging.

ITEM #	DESCRIPTION
4WX2H-G-MESH	4'w x 2'h Vinyl Banner
5WX3H-G-MESH	5'w x 3'h Vinyl Banner
6WX2H-G-MESH	6'w x 2'h Vinyl Banner
6WX3H-G-MESH	6'w x 3'h Vinyl Banner
6WX4H-G-MESH	6'w x 4'h Vinyl Banner
8WX3H-G-MESH	8'w x 3'h Vinyl Banner
8WX4H-G-MESH	8'w x 4'h Vinyl Banner
10WX3H-G-MESH	10'w x 3'h Vinyl Banner
10WX4H-G-MESH	10'w x 4'h Vinyl Banner



13 OZ. SCRIM SINGLE-SIDED

Durable and weather-resistant, scrim hanging banners are ideal for long-term outdoor use.

ITEM #	DESCRIPTION
4WX2H-G-OB13	4'w x 2'h Vinyl Banner
5WX3H-G-OB13	5'w x 3'h Vinyl Banner
6WX2H-G-OB13	6'w x 2'h Vinyl Banner
6WX3H-G-OB13	6'w x 3'h Vinyl Banner
6WX4H-G-OB13	6'w x 4'h Vinyl Banner
8WX3H-G-OB13	8'w x 3'h Vinyl Banner
8WX4H-G-OB13	8'w x 4'h Vinyl Banner
10WX3H-G-OB13	10'w x 3'h Vinyl Banner
10WX4H-G-OB13	10'w x 4'h Vinyl Banner



18 OZ. SCRIM VINYL SINGLE & DOUBLE-SIDED

18oz scrim banners are long-lasting and can be made single or double-sided.

ITEM #	DESCRIPTION
2WX4H-G-OB18-GDBL	2'w x 4'h 18oz. Double-Sided Scrim
2WX6H-G-OB18-GDBL	2'w x 6'h 18oz. Double-Sided Scrim
3WX6H-G-OB18-GDBL	3'w x 6'h 18oz. Double-Sided Scrim
4WX2H-G-OB18	4'w x 2'h 18oz. Single-Sided Scrim
5WX3H-G-OB18	5'w x 3'h 18oz. Single-Sided Scrim
6WX2H-G-OB18	6'w x 2'h 18oz. Single-Sided Scrim
6WX2H-G-OB18-GDBL	6'w x 2'h 18oz. Double-Sided Scrim
6WX3H-G-OB18	6'w x 3'h 18oz. Single-Sided Scrim
6WX3H-G-OB18-GDBL	6'w x 3'h 18oz. Double-Sided Scrim
6WX4H-G-OB18	6'w x 4'h 18oz. Single-Sided Scrim
8WX3H-G-OB18	8'w x 3'h 18oz. Single-Sided Scrim
8WX3H-G-OB18-GDBL	8'w x 3'h 18oz. Double-Sided Scrim
8WX4H-G-OB18	8'w x 4'h 18oz. Single-Sided Scrim
8WX4H-G-OB18-GDBL	8'w x 4'h 18oz. Double-Sided Scrim
10WX3H-G-OB18	10'w x 3'h 18oz. Single-Sided Scrim
10WX4H-G-OB18	10'w x 4'h 18oz. Single-Sided Scrim

6.5 OZ. OUTDOOR CANVAS SINGLE-SIDED

Outdoor canvas banners are water and UV resistant, making them a top choice for use in many outdoor events.

ITEM #	DESCRIPTION
4WX2H-G-ODC	4'w x 2'h
5WX3H-G-ODC	5'w x 3'h
6WX2H-G-ODC	6'w x 2'h
6WX3H-G-ODC	6'w x 3'h
6WX4H-G-ODC	6'w x 4'h
8WX3H-G-ODC	8'w x 3'h
8WX4H-G-ODC	8'w x 4'h
10WX3H-G-ODC	10'w x 3'h
10WX4H-G-ODC	10'w x 4'h



call for large quantity pricing!

OUTDOOR TENTS

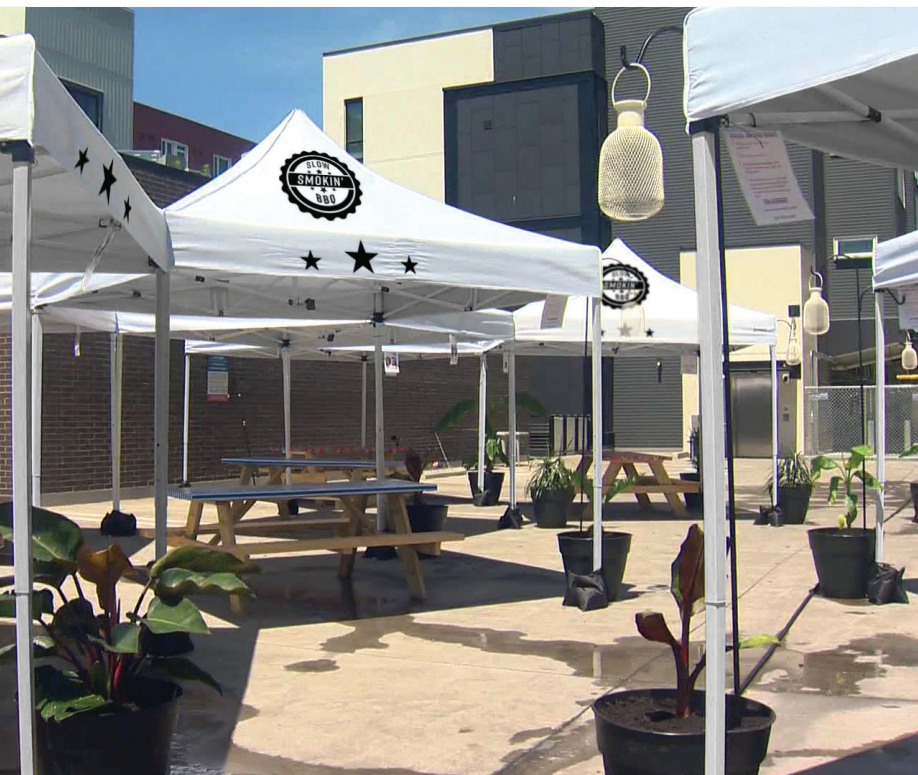

OUTDOOR TENTS

ZOOM™ ECONOMY (STEEL) 5' POPUP TENT

Features include:

- opens to a base size of 4.7' x 4.7'
- black powder coated economy steel tent frame is completely self-contained with no loose parts
- canopies are water and UV resistant
- hardware kit includes frame, stakes, guy lines and rolling carry bag
- canopy kits include custom printed canopy, hardware frame, guy lines and rolling carry bag



ITEM #	DESCRIPTION
P02A0089	Printed Canopy Graphic & Hardware Kit
ZM-TNT-ECO-1.5MX1.5M-FRM-SQU-2	Hardware only

call for quantities over 100

tent light kit available



quick & easy assembly in minutes!



ZOOM™ ECONOMY (STEEL) 10' POPUP TENT

Features include:

- opens to a base size of 9.8' x 9.8'
- black powder-coated economy steel frame is completely self-contained with no loose parts
- canopies, half walls and full walls offered in 5 stock colors and can also be custom printed; water & UV resistant
- hardware only kit includes frame, stakes, guy lines and rolling carry bag
- canopy kits include canopy (standard colors or custom printed), hardware frame, stakes, guy lines and rolling carry bag
- half and full walls sold separately & interchangeable between economy & standard frames

seams feature rubber beading to repel water



ITEM #	DESCRIPTION
P02A0092	Printed Canopy Graphic & Hardware Kit
ZM-TNT-ECO-3MX3M-FRM-SQU-2	Hardware only



All Outdoor products have a one year limited frame warranty and are eco-friendly.

OUTDOOR TENTS

ZOOM™ STANDARD (ALUMINUM) 10' POPUP TENT

Features include:

- 10' opens to a base size of 9.8' x 9.8'
- **rust-resistant**, lightweight aluminum frame is completely self-contained with no loose parts
- custom printed canopies are water & UV resistant
- hardware only kit includes frame, stakes, guy lines and rolling carry bag
- canopy kits include water-resistant canopy, hardware frame, stakes, guy lines and rolling carry bag
- half and full walls sold separately & interchangeable between economy & standard frames



ITEM #	DESCRIPTION
P02A0097	Printed Canopy Graphic & Hardware Kit
ZM-TNT-STD-3MX3M-FRM-HEX	Hardware only

ZOOM™ 10' HALF & FULL WALLS

Features include:

- compatible with both Zoom™ Standard and Economy tent frames
- half wall kit includes half wall panel, half wall pole and two brackets
- full wall kits include full wall panel
- graphics are water and UV resistant

ITEM #	DESCRIPTION
ZM-TNT-1.5MX1.5M-FLL-WLL-G	5' Single-Sided Tent Full Wall Graphic
ZM-TNT-3MX3M-FLL-WLL-G	10' Single-Sided Tent Full Wall Graphic
ZM-TNT-3MX6M-FLL-WLL-G	20' Single-Sided Tent Full Wall Graphic
ZM-TNT-3MX3M-HLF-WLL-G	10' Single-Sided Tent Half Wall Graphic
ZM-TNT-3MX6M-HLF-WLL-G	20' Single-Sided Tent Half Wall Graphic (kit of 2 - 10' half wall graphics)
ZM-TNT-3MX3M-HLFWLL-KIT	Half Wall Hardware Only for Economy & Standard 3x3 Tents



tents for restaurants, outdoor classrooms and more!



All Outdoor products have a one year limited frame warranty and are eco-friendly.

OUTDOOR TENTS



ZOOM™ 20' (ALUMINUM) POPUP TENTS

Features include:

- 20' opens to a base size of 9.8' x 19.6'
- **rust-resistant**, lightweight aluminum frame is completely self-contained with no loose parts
- custom printed canopies are water & UV resistant
- hardware only kit includes frame, stakes, guy lines and rolling carry bag
- canopy kits include water-resistant canopy, hardware frame, stakes, guy lines and rolling carry bag
- half and full walls sold separately

ITEM #	DESCRIPTION
P02A0113	Printed Canopy Graphic & Hardware Kit
ZM-TNT-STD-3MX6M-FRM-HEX	Hardware only

make sure it's aluminum!

NEVER RUSTS, LASTS LONG



All Outdoor products have a one year limited frame warranty and are eco-friendly.

INTERIOR BANNERS, STANDS & SIGNS





RETRACTABLE BANNER STANDS

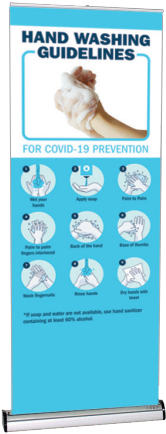

IMAGINE 800

- variable graphic height = 30.5" - 83.35"
- graphic tensioner
- integrated pole storage
- interchangeable graphic cassette
- adjustable feet on base
- telescopic pole



31.5" WIDE

ITEM #	DESCRIPTION
P01Q0011	31.5"w Economy Anti-curl Vinyl Kit
IMG-800-S	Hardware only

*kits include hardware, graphic & carry bag

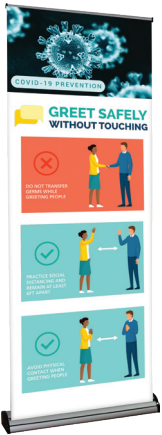

BARRACUDA 800

- variable graphic height = 60" - 83"
- anodized silver base
- toolless quick rail
- graphic tensioner
- adjustable leveling feet
- hybrid bungee/telescopic pole
- includes carry bag



31.5" WIDE

ITEM #	DESCRIPTION
P01Q0003	31.5"w Economy Anti-curl Vinyl Kit
BCD-800-S-1	Hardware only

*kits include hardware, graphic & carry bag

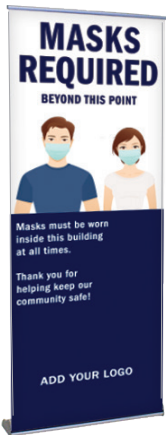

ORIENT 800

- variable graphic height = 60.5" - 83.25"
- anodized silver base
- toolless quick rail combines the ease of a snap rail with the reassurance of an adhesive fixing
- molded end caps
- adjustable leveling feet
- hybrid bungee/telescopic pole
- includes carry bag



31.5" WIDE

ITEM #	DESCRIPTION
P01R0017	31.5"w Economy Anti-curl Vinyl Kit
ONT-800-S-4	Hardware only

*kits include hardware, graphic & carry bag



BLADE LITE 800

- 31.5"-59" variable graphic height = 60" - 83.25"
- silver base with chrome-finish end caps
- toolless quick rail combines the ease of a snap rail with the reassurance of an adhesive fixing
- weighted base for stability
- adjustable leveling feet
- hybrid bungee/telescopic pole
- includes carry bag



31.5" WIDE

ITEM #	DESCRIPTION
P01R0005	31.5"w Economy Anti-curl Vinyl Kit
BLD-LT-800-1	Hardware only

*kits include hardware, graphic & carry bag

RETRACTABLE BANNER STANDS

90 DAY



PHOENIX 850

- standard graphic height = 79"
- anodized silver base
- swivel feet & snap top graphic rail
- 3-piece bungee pole
- includes carry bag



33.5" WIDE

ITEM #	DESCRIPTION
PO3R0045	33.5"w Economy Anti-curl Vinyl Kit - Silver
PHX-850-S	Silver hardware only

*kits include hardware, graphic & carry bag

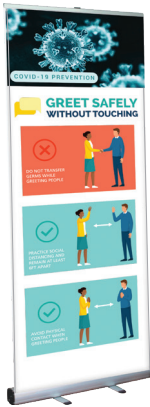

MOSQUITO 850

- standard graphic height = 78.5"
- swivel feet & snap top graphic rail
- 3-piece bungee pole
- includes carry bag



33.5" WIDE

ITEM #	DESCRIPTION
PO3R0029	33.5"w Economy Anti-curl Vinyl Kit - Silver
MSQT-850	Silver hardware only

*kits include hardware, graphic & carry bag



MOSQUITO 800

- standard graphic height = 78.5"
- anodized silver or black base options (31.5" only)
- swivel feet & snap top graphic rail
- 3-piece bungee pole
- includes carry bag



31.5" WIDE

ITEM #	DESCRIPTION
PO3R0007	31.5"w Economy Anti-curl Vinyl Kit - Silver
MSQT-800-S	Silver hardware only
PO3R0009	31.5"w Economy Anti-curl Vinyl Kit - Black
MSQT-800-B	Black hardware only

*kits include hardware, graphic & carry bag

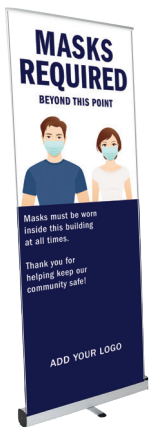

MOSQUITO LITE

- standard graphic height = 78.5"
- anodized silver base
- swivel foot & snap top graphic rail
- 3-piece bungee pole
- includes carry bag



31.5" WIDE

ITEM #	DESCRIPTION
PO3R0015	31.5"w Economy Anti-curl Vinyl Kit
MSQT-LT-800	Hardware only

*kits include hardware, graphic & carry bag



ALL RETRACTABLE BANNER STANDS COME IN A PORTABLE BAG



INDOOR HANGING BANNERS

13 OZ. ANTI-CURL VINYL SINGLE-SIDED

Durable and lightweight, the single-sided 13 oz. anti-curl vinyl banner is a perfect choice for displays in high-traffic environments.

ITEM #	DESCRIPTION
4WX2H-G-ACV	4'w x 2'h Vinyl Banner
5WX3H-G-ACV	5'w x 3'h Vinyl Banner
6WX2H-G-ACV	6'w x 2'h Vinyl Banner
6WX3H-G-ACV	6'w x 3'h Vinyl Banner
6WX4H-G-ACV	6'w x 4'h Vinyl Banner
8WX3H-G-ACV	8'w x 3'h Vinyl Banner
8WX4H-G-ACV	8'w x 4'h Vinyl Banner
10WX3H-G-ACV	10'w x 3'h Vinyl Banner
10WX4H-G-ACV	10'w x 4'h Vinyl Banner



also available in custom sizes

FABRIC SINGLE-SIDED

Display Poly and Oxford fabric hanging banners are quality choices for indoor advertisements.

ITEM #	DESCRIPTION
4WX2H-G-DP	4'w x 2'h Display Poly
4WX2H-G-OX	4'w x 2'h 8oz. Oxford
5WX3H-G-DP	5'w x 3'h Display Poly
5WX3H-G-OX	5'w x 3'h 8oz. Oxford
6WX2H-G-DP	6'w x 2'h Display Poly
6WX2H-G-OX	6'w x 2'h 8oz. Oxford
6WX3H-G-DP	6'w x 3'h Display Poly
6WX3H-G-OX	6'w x 3'h 8oz. Oxford
6WX4H-G-DP	6'w x 4'h Display Poly
6WX4H-G-OX	6'w x 4'h 8oz. Oxford
8WX3H-G-DP	8'w x 3'h Display Poly
8WX3H-G-OX	8'w x 3'h 8oz. Oxford
8WX4H-G-DP	8'w x 4'h Display Poly
8WX4H-G-OX	8'w x 4'h 8oz. Oxford
10WX3H-G-DP	10'w x 3'h Display Poly
10WX3H-G-OX	10'w x 3'h 8oz. Oxford
10WX4H-G-DP	10'w x 4'h Display Poly
10WX4H-G-OX	10'w x 4'h 8oz. Oxford



same pricing for all finishing options!

INDOOR & OUTDOOR FINISHING STYLES



no finishing (vinyl)

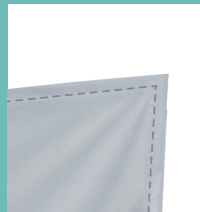

hem only (fabric)



hem & #3 grommet



rope & #3 grommet



3" pole pocket

TRAPPA POSTER FRAMES & WAYFINDING SIGNS



TRAPPA POSTER FRAME



- black or silver anodized finish with precision mitered corners
- spring loaded aluminum extrusions mounted to a high-impact polystyrene backer
- trappa frame edges snap open from the front to allow quick and easy graphic changes with no tools required
- available in a wide range of standard sizes & includes a clear anti-glare lens
- custom sizes also offered

	ITEM #	DESCRIPTION
8.5"W 11"H	TRP2-1	Black Frame Silver Frame
11"W 14"H	TRP2-2	Black Frame Silver Frame
11"W 17"H	TRP2-11	Black Frame Silver Frame
12"W 18"H	TRP2-12	Black Frame Silver Frame
16"W 20"H	TRP2-4	Black Frame Silver Frame
18"W 24"H	TRP2-10	Black Frame Silver Frame
20"W 24"H	TRP2-5	Black Frame Silver Frame
22"W 28"H	TRP2-7	Black Frame Silver Frame
24"W 30"H	TRP2-8	Black Frame Silver Frame
30"W 40"H	TRP2-9	Black Frame Silver Frame

SIGNPRO®

S Y S T E M S

INTERIOR WAYFINDING SIGN SOLUTIONS



- \\ Wayfinding Sign Solutions for directional guidance in offices, hospitals, retail environments, schools and more to help visitors navigate through buildings with ease.
- \\ Ever-increasing custom capabilities; we can build frames and signs suited to your exact specifications
- \\ Engineered, supplied & **manufactured in the USA.**
- \\ Fast. Affordable. Excellent Quality.



- \\ **Made in USA**
- \\ **Fast production**
- \\ **Quick ship**

INTERIOR BANNERS, STANDS & SIGNS

WAYFINDING SIGNS



ADVOCATE

- chrome finish holder, post and circular base
- holds 8.5" w x 11" h sign
- telescoping post offers variable heights from up to 30.5" - 48"
- frame can be rotated 360° or at any desired angle

ITEM #	DESCRIPTION
ADVOCATE	30.5" - 48" Aluminum 7.75" w x 10.25" h Sign Holder



SNAPPER STAND

- snap-edge 11" w x 17" h sign frame, portrait or landscape orientation
- holds 11" w x 17" h poster, recommended thickness 1/32"
- includes clear non-glare protective lens
- two-piece collapsible anodized aluminum post
- silver powder-coated steel base

ITEM #	DESCRIPTION
SNP-STAND	40" Silver Aluminum 11" w x 17" h Sign Holder



OBSERVE PRO

- lightweight, snap together design
- stylish curved header holds 8.5" w x 11" h graphic
- adjustable literature rack for 8.5" w x 11" h printed literature
- molded sign clamp will hold an 1/8" thick mounted graphic
- base dimension: 12" dia.
- option A - no graphic: 12" w x 42" h
- option B - with header: 12" w x 48" h

ITEM #	DESCRIPTION
OBS-LP-SYS	42" h Info Center with Header & Lit Pocket



TRAPPA TUBE SIGN STAND

- 11" x 17" silver Trappa poster frame with clear, protective lens
- front loading graphic mechanism makes graphic changes easy
- capability to display in portrait or landscape configuration
- aluminum snap-button tube and plastic base
- assembled dimensions = 12" w x 48.22" h x 12" d

ITEM #	DESCRIPTION
TRAPPA-TUBE-STAND	48.22" h Aluminum 11" x 17" Sign Holder



TRAPPA POST INFO CENTER

- snap sign frame(s)
- variety of configurations and sizes
- sturdy aluminum posts and heavy domed steel base plate ensures stability
- includes clear protective lenses
- choice of silver or black snap, large or small landscape, portrait or diagonal
- front loading graphic mechanism makes graphic changes easy

ITEM #	DESCRIPTION
TP4-B	3 Straight Frames - 20" w x 16" h, Black
TP4-S	3 Straight Frames - 20" w x 16" h, Silver

inform & educate customers or employees

